

# TR-8

MODEL ROCKET  
TECHNICAL REPORT

# MODEL ROCKETRY STUDY GUIDE

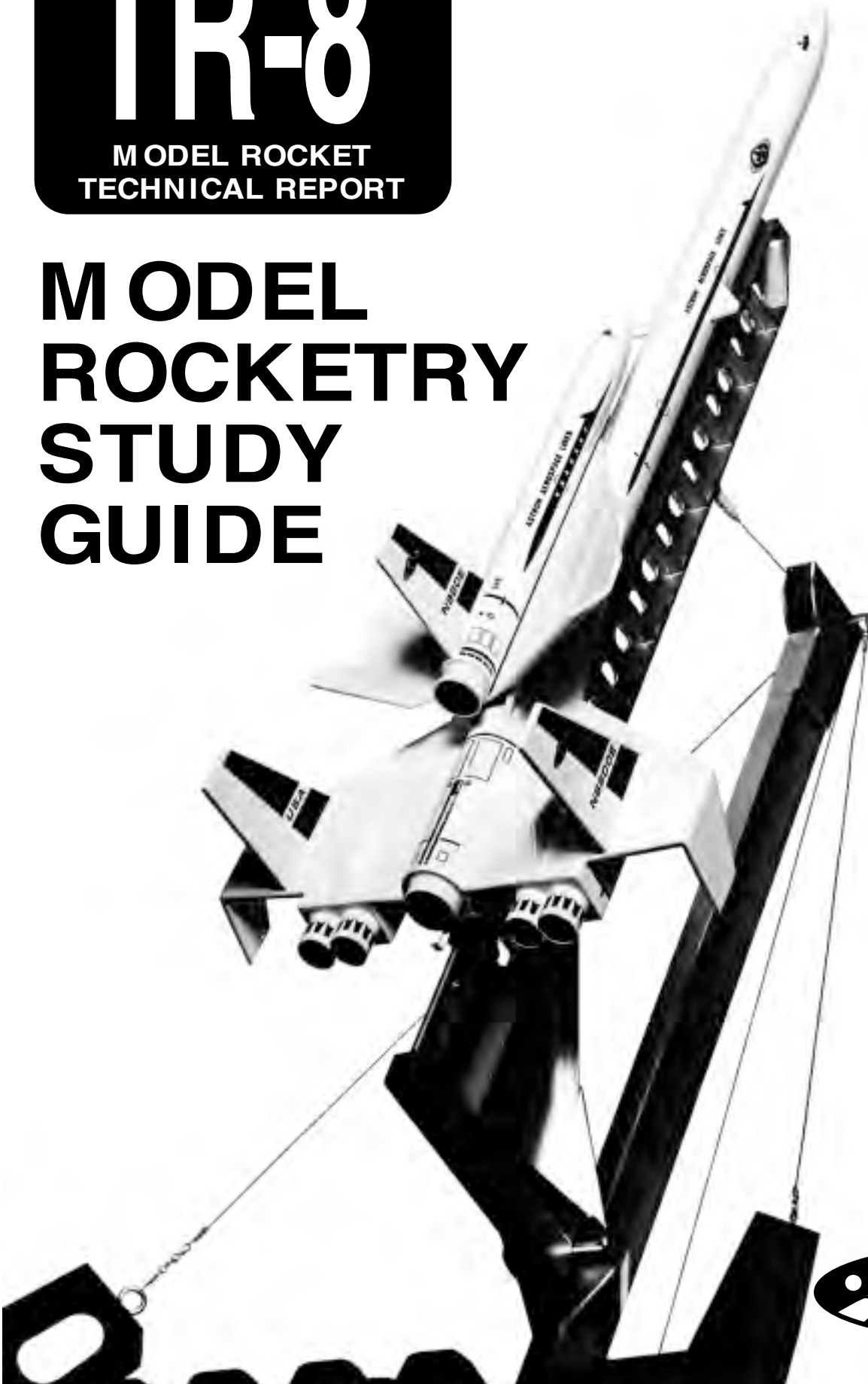

# ARMED AND COUNTING

Becoming an expert model rocketeer requires basic knowledge, skills and experience acquired through a planned program of study and activity. By following this guide step-by-step and completing the reviews at the end of each section, you will obtain much self-satisfaction in accomplishment and obtain great benefit and enjoyment from the exciting world of solid propellant model rocketry.

## DEDICATION

This publication is dedicated to the millions of rocketeers who, since 1958, have developed the hobby/sport of model rocketry to its present level of sophistication. Without their dedicated efforts to make and keep model rocketry a safe and exciting technical hobby, the miniature technology of model rocketry as we know it today would not exist. They have all helped to prove - Model Rocketry is Fun!

Updated by Ann Grimm

Copyright 1972, 1985, 1999 Centuri Corporation. All rights reserved.

EST 2841

# CONTENTS

SECTION I Basic Model Rocketry .....	1
GLOSSARY Basic Terms .....	5
SECTION REVIEW .....	10
SECTION II Advanced Model Rocketry .....	13
GLOSSARY Advanced Terms .....	20
SECTION REVIEW .....	26
SECTION III Boost - Gliders.....	29
GLOSSARY Glider Terms.....	31
SECTION REVIEW .....	36
FINAL EXAM.....	38
PROJECT / FLIGHT RECORD.....	41



# SECTION I

## BASIC MODEL ROCKETRY

**T-10** Read The Model Rocketry Technical Manual #2819. This manual on model rocketry is a fine beginner's guide. Later, it serves as a handy reference as you advance in model rocketry. Understanding the basic information that is offered in the manual is a must if you hope to become an expert in your model rocket activities.

**T-9** Learn the basic parts of a model rocket.

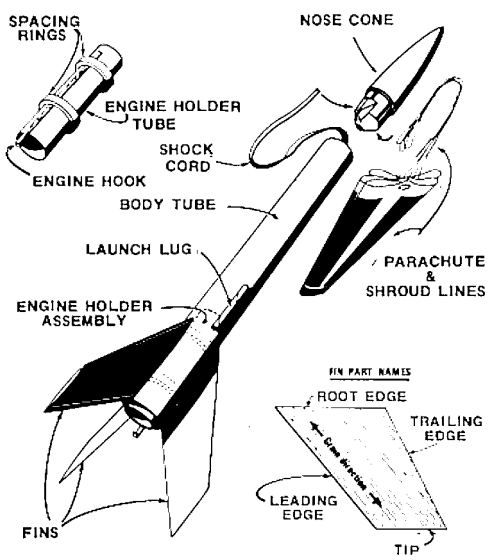

Study the flight phases of a model rocket.

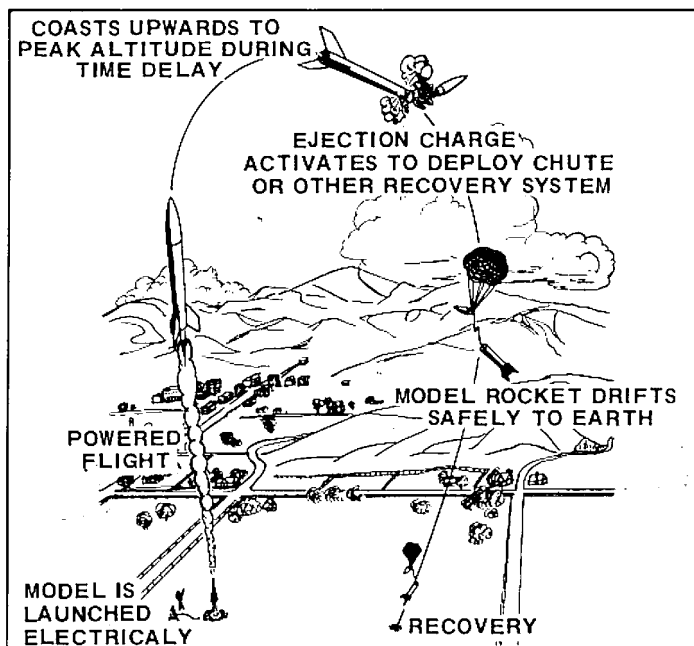

**T-8** Obtain the basic modeling tools and materials. These should include at least the following:

- Modeling knife
- Ruler
- Sandpaper (fine or extra fine)
- Scissors
- White or yellow glue
- Pencil
- Cutting board or piece of heavy cardboard
- Sanding sealer
- Paint brush
- Paint (spray enamel)
- Paint thinner

**T-7** Learn the basic modeling techniques. If your model rocket is to perform in the manner for which it was designed, care is necessary in assembly. The skill needed for proper construction can be acquired only by practicing with the tools and materials listed above. If you are not already an experienced modeler, we suggest that you practice the following techniques as illustrated in the Model Rocketry Technical Manual #2819.

a. Measure distances on scrap balsa with a ruler, then mark and draw lines for cutting. With a modeling knife, cut the balsa along the marked lines. This exercise is extremely important since it will help you learn to cut your fins accurately. Do not forget that the grain of the balsa should always run the same direction as the leading edge of the fin.

b. With scrap balsa, practice sanding the surfaces and edges to the correct shape with a smooth finish. Remember that the root edges of the fins must be sanded "square" to insure a perfect fit to the body. The leading and trailing edges must be rounded to insure greater aerodynamic efficiency. A smooth finish reduces drag to a minimum and permits maximum performance.

c. Learn glue application techniques by gluing pieces of cardboard and balsa together. Experience will teach you the proper amount of glue required, drying time, etc. Joints should always be reinforced by applying a smooth reinforcement of glue. This adds to the appearance of your rocket as well as increasing aerodynamic efficiency.

d. Practice sealing and painting techniques to achieve a fine finish. Cover all balsa parts with two or three brushed coats of sanding sealer. Be sure to let dry and sand all areas lightly with fine sandpaper between coats. Base color and second colors, either sprayed or brushed, should always be applied in thin coats. Remember that the performance of your rocket as well as its appearance will be affected by the finish.



## LAUNCH SITE DIMENSIONS

INSTALLED TOTAL IMPULSE (newton-seconds)	EQUIVALENT ENGINE TYPE	MINIMUM SITE DIMENSION (FEET) (METERS)	
0.00-1.25	1/4 A & 1/2 A	50	15
1.26-2.50	A	100	30
2.51-5.00	B	200	60
5.01-10.00	C	400	120
10.01-20.00	D	500	150
20.01-40.00	E	1000	300
40.01-80.00	F	1000	300
80.01-160.00 G	1000	300	
160.01-320.00	2Gs	1500	450

8. **Launcher** - I will launch my model rocket from a stable launch device that provides rigid guidance until the model rocket has reached a speed adequate to ensure a safe flight path. To prevent accidental eye injury, I will always place the launcher so the end of the rod is above eye level or I will cap the end of the rod when approaching it. I will cap or disassemble my launch rod when not in use, and I will never store it in an upright position. My launcher will have a jet deflector device to prevent the engine exhaust from hitting the ground directly. I will always clear the area around my launch device of brown grass, dry weeds, or other easy-to-burn materials.
9. **Ignition System** - The system I use to launch my model rocket will be remotely controlled and electrically operated. It will contain a launching switch that will return to "off" when released. The system will contain a removable safety interlock in series with the launch switch. All persons will remain at least 15 feet (5 meters) from the model rocket when I am igniting model rocket engines totaling 30 newton-seconds or less of total impulse. I will use only electrical igniters recommended by the engine manufacturer that will ignite model rocket engine(s) within one second of actuation of the launching switch.
10. **Launch Safety** - I will ensure that people in the launch area are aware of the pending model rocket launch and can see the model rocket's liftoff before I begin my audible five-second countdown. I will not launch a model rocket using it as a weapon. If my model rocket suffers a misfire, I will not allow anyone to approach it or the launcher until I have made certain that the safety interlock has been removed or that the battery has been disconnected from the ignition system. I will wait one minute after a misfire before allowing anyone to approach the launcher.
11. **Flying Conditions** - I will launch my model rocket only when the wind is less than 20 miles (30 kilometers) an hour. I will not launch my model rocket so it flies into clouds, near aircraft in flight, or in a manner that is hazardous to people or property.
12. **Pre-Launch Test** - When conducting research activities with unproven model rocket designs or methods I will, when possible, determine the reliability of my model rocket by pre-launch tests. I will conduct the launching of an unproven design in complete isolation from persons not participating in the actual launching.
13. **Launching Angle** - My launch device will be pointed within 30 degrees of vertical. I will never use model rocket engines to propel any device horizontally.
14. **Recovery Hazards** - If a model rocket becomes entangled in a power line or other dangerous place, I will not attempt to retrieve it.

This is the official Model Rocketry Safety Code of the National Association of Rocketry and the Model Rocket Manufacturers Association.

As a member of the Estes Model Rocketry Program, I promise to faithfully follow all rules of safe conduct as established in the above code.

Signature: \_\_\_\_\_

- T-4 Study the performance of model rocket engines. Learn the various parts of a model rocket engine and why different engines are recommended for specific missions. Rocket engine design, classification, operation and performance are explained in the Model Rocketry Technical Manual # 2819.

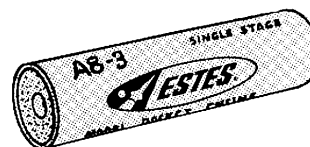

## T-6

For your first rocket build the Alpha® or the Alpha III®. Each is a single stage model rocket by Estes with parachute recovery. The Alpha® is an excellent model for both beginners and experienced rocketeers. Building and launching this rocket will teach you the basic principles of model rocket technology and provide you with a background for advancement to multi-stage, boost-glider and scale model rockets.

Read the instructions carefully before starting construction. To prevent a mistake, be sure to follow the instruction sheet step by step. Don't learn the hard way!

Examine the parts packed in the kit with the Parts List given in the instruction sheet.

Now, construct and finish your model using the proper tools, knowledge and skills gained from practice.

## T-5

Learn the Model Rocketry Safety Code. Be an expert and keep your model rocket activities safe and enjoyable by following the Safety Code at all times.

## NAR Model Rocketry Safety Code

1. **Materials** - My model rocket will be made of lightweight materials such as paper, wood, rubber, and plastic suitable for the power used and the performance of my model rocket. I will not use any metal for the nose cone, body, or fins of a model rocket.
2. **Engines/Motors** - I will use only commercially-made NAR certified model rocket engines in the manner recommended by the manufacturer. I will not alter the model rocket engine, its parts, or its ingredients in any way.
3. **Recovery** - I will always use a recovery system in my model rocket that will return it safely to the ground so it may be flown again. I will use only flame resistant recovery wadding if required.
4. **Weight and Power Limits** - My model rocket will weigh no more than 1,500 grams (53 ounces) at liftoff, and its rocket engines will produce no more than 320 newton-seconds (4.45 newtons equal 1.0 pound) of total impulse. My model rocket will weigh no more than the engine manufacturer's recommended maximum liftoff weight for the engines use, or I will use engines recommended by the manufacturer for my model rocket.
5. **Stability** - I will check the stability of my model rocket before its first flight, except when launching a model rocket of already proven stability.
6. **Payloads** - Except for insects, my model rocket will never carry live animals or a payload that is intended to be flammable, explosive, or harmful.
7. **Launch Site** - I will launch my model rocket outdoors in a cleared area, free of tall trees, power lines, building and dry brush and grass. My launch site will be at least as large as that recommended in the following table.

Do not make engine substitutions different than catalog and instruction recommendations.

A review of Newton's Third Law of Motion ("For every action there is an equal and opposite equal reaction") will help you in gaining a better understanding of model rocket operation. For more information on Newton's laws of motion refer to Newton's Laws of Motion and Model Rocketry #2821.

**T-3** Build an electrical ignition system for launching your model rockets. The Estes Electron Beam® Launch Controller with Porta Pad® II Launcher is an excellent combination. Remember the Safety Code states that the only safe way to launch model rockets is by electrical means.



Refer to the Model Rocketry Technical Manual #2819 or Model Rocket Launch Systems #2811 for basic understanding of model rocket launch systems. A review of basic electricity, electrical circuits, Ohm's Law, etc., will allow you to gain additional understanding of launch systems and engine ignition.

Symbols Used in Electrical Circuits	
	ground
	wire
	two connected wires
	two wires not connected
	three connected wires
	four connected wires
	two wires not connected
	switch open
	switch closed
	resistor
	electric light
	single dry cell (produces 1.5 volts)
	battery (a battery is two or more cells connected in series).

More comprehensive information concerning launch systems is featured in the Estes publication, Model Rocket Launch Systems #2811. This booklet is especially valuable if you are building your own launch system.



**T-2** Carefully prepare your model rocket for launching. Follow the instructions outlined in the instruction sheet provided in your kit. Remember, don't neglect the details of proper preparation.



**T-1** "Blast-off." Launch your rocket!  
Be sure to carry out a pre-flight safety check of the launch area and a short count down before lift off. By following this guide step by step, your first flight will be a successful one. Be sure to record your first launch in your Project Flight Record.

# NOTES

## BASIC TERMS

**Airfoil:**

A cross-section of a body designed to produce a lifting force perpendicular to its surface when there is a relative motion between it and the surrounding air.

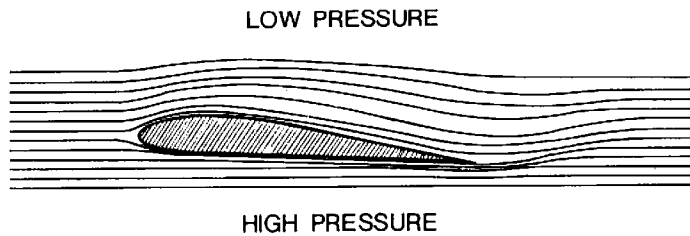
**Amateur Rocketry:**

Professionally supervised rocketry activities carried out by knowledgeable amateurs.

**Ampere (amp):**

The unit used in measuring the strength of an electrical current; an ampere is equal to the steady current produced by one volt applied across the resistance of one ohm.

**Apogee:**

The point in the orbit of a satellite where it is farthest from Earth.

**Armed:**

Term used to signify the moment an ignition system is activated to check continuity allowing the countdown to begin.

**Average Thrust:**

The total impulse of a rocket engine divided by the time duration of its thrust; the thrust that an engine would have if its thrust were constant from ignition to burnout.

**Balsa Wood:**

A very light, strong wood grown in Ecuador and used in the structure of model airplanes and model rockets.

**Basement Bomber:**

Person with inadequate knowledge who attempts to mix his own propellant and usually builds his rockets out of metal.

**Blast Deflector:**

Metal plate that protects launcher base and ground from rocket's exhaust.

**Body Tube:**

Light cardboard cylinder that is the main frame for the rocket.

**Burnout:**

The point at which a rocket engine ceases to produce thrust; generally, the point at which all propellant has been burned.

**Centerbore:**

Round cavity in propellant grain for easy ignition and controlled burn.

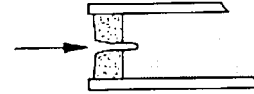
**Center (core) burning:**

Model rocket engine with deep centerbore providing a large propellant burning area resulting in a high thrust level.

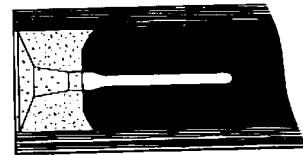
**Center of Gravity:**

The point in a rocket around which its weight is evenly balanced; the point at which a model rocket will balance on a knife edge.

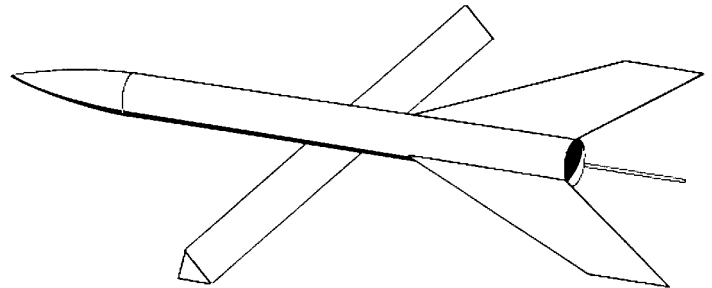
**Circuit:**

The complete path of an electric current including the source of electric energy.

**Coast Period:**

Mid-flight phase between burnout and activation of ejection charge during which a delay element emits a smoke trail.

**Countdown:**

Practice of verbally counting down to launch a rocket. Example: "5..4..3..2..1.. Ignition"

**Current:**

The movement of electricity or rate of electrical flow; measured in amperes.

**Delay Element:**

A slow-burning chemical loaded into a model rocket engine during manufacture to provide a time delay and a smoke trail between burnout and the activation of the recovery system.

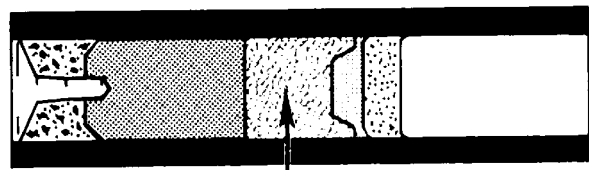

DELAY ELEMENT



### Ejection Charge:

Charge contained in single and upper stage engines which deploys the recovery device.

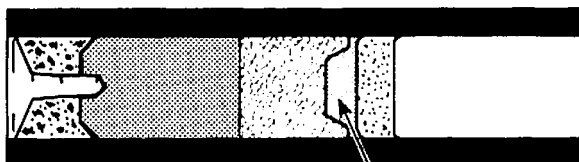

EJECTION CHARGE

### End-Burning:

Solid propellant rocket engine which is ignited at the nozzle end and burns through to the forward end; model rocket engine with slight centerbore producing a high initial thrust dropping off to a sustaining level.

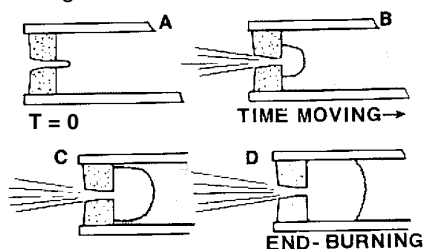

### Engine Block (Mount):

A hollow block or ring positioned in a model rocket body to prevent the engine from moving forward during acceleration while allowing a free forward travel of the ejection gases.

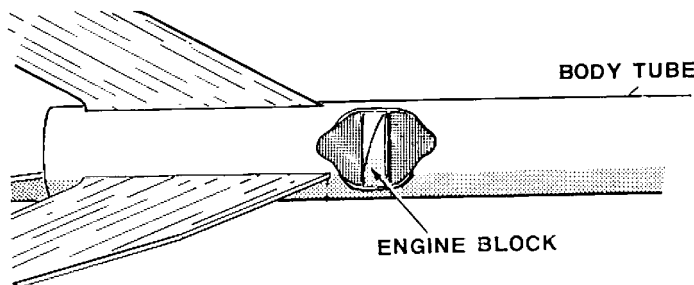

### Engine Classification:

Code designation, stamped on engines, giving data on an engine's performance capabilities.

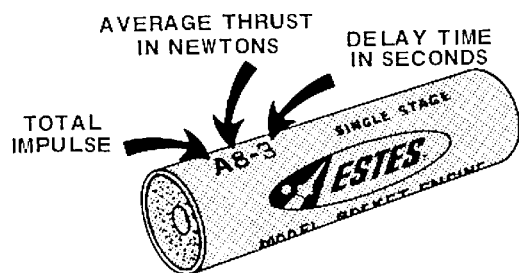

### Fin:

The stabilizing and guiding unit of a model rocket (which should be in a symmetrical form of three, four, or possibly more and made of reinforced paper, balsa, or plastic); an aerodynamic surface projecting from the rocket body for the purpose of giving the rocket directional stability.

### Finishing:

The art of producing a quality surface on the model rocket. A well-finished rocket with a smooth surface and properly filleted fins with adequate airfoil will allow a model to perform better than a model not so finished.

### Glue Reinforcement:

To place glue or other reinforcing material at the joint of the fin and the body tube. It provides greater strength at a point where maximum stress will be applied during flight and reduces fin-body interference drag. Also known as a fillet.

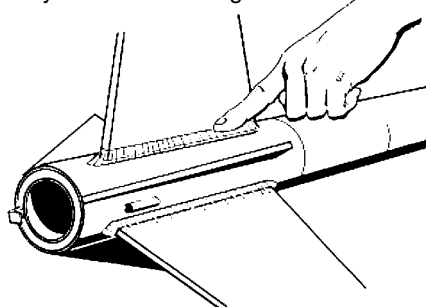

### Grain, Balsa:

The grain of any wood is the direction in which the fibers run.

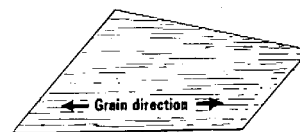

### Igniter:

An electrical device which initiates the combustion process in a rocket engine.

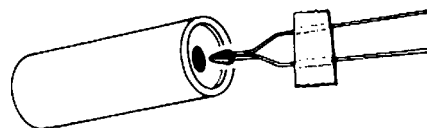

### Ignition:

The instant at which a model rocket engine's propellant begins to burn.

### Ignition System:

Electrical system used to ignite a model rocket engine. (See drawing of launch pad.)

### Launch Lug:

Round, hollow tube which slips over the launch rod to guide the model during the first few feet of flight until stabilizing velocity is reached.

(See drawing of launch pad.)

### Launch Pad:

Structure used to support and guide a model in a vertical path during the first few feet of flight until stabilizing velocity is reached; includes blast deflector to deflect rocket's exhaust.

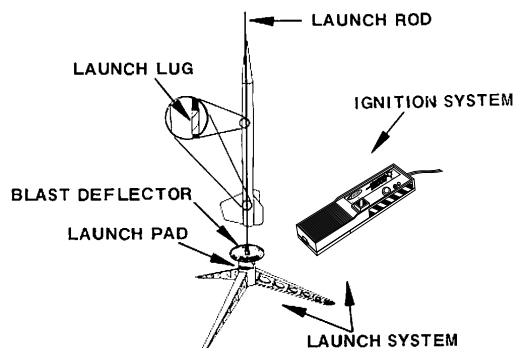

### Launch Rod:

Rod used to support and guide a model in a vertical path during the first few seconds of flight until stabilizing velocity is reached. (See drawing of launch pad.)

**Launch System:**

Combination of ignition system and launch pad. (See drawing of launch pad.)

**Leading Edge:**

The very front surface of a fin or a boost-glider wing that is exposed to the greatest amount of air pressure build up. The grain of the balsa wood should run parallel to the leading edge to allow for maximum strength.

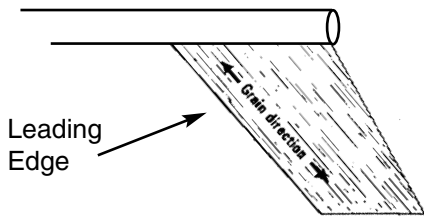

**Lift-Off:**

First motion of a rocket after ignition.

**Micro-clip:**

Tiny, flat-jawed alligator clip used to attach the ignition system to the igniter.

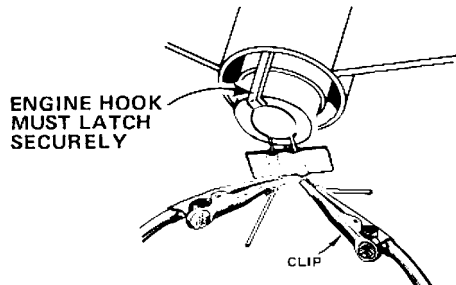

**Model Rocket, Solid Propellant:**

A rocket made of light materials such as paper, wood, plastic or rubber without the use of substantial metal parts, powered by a commercially manufactured solid propellant model rocket engine; rising without the necessity of lift-producing aerodynamic surfaces; and containing a recovery device to lower it safely back to the ground.

**Model Rocket Engine, Solid Propellant:**

A commercially manufactured, solid propellant rocket engine in which all chemical ingredients of a combustible nature are pre-loaded and ready for use.

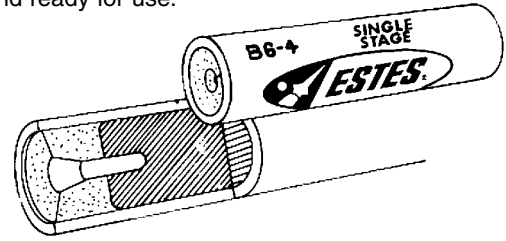

**newton:**

The amount of force needed to move a mass of one kilogram with an acceleration (change in velocity) of one meter per second each second; one newton is equal to 0.225 pounds of force.

**newton-second:**

Metric measurement for a rocket's total impulse.

**Newton's Third Law:**

"For every action there is an equal and opposite equal reaction."

**Nose Cone:**

The foremost surface of a model rocket, generally tapered in shape to allow for streamlining, usually made of balsa or plastic.

**Nozzle:**

The exhaust duct of a rocket combustion chamber in which gases are accelerated to higher velocities.

**NOZZLE**

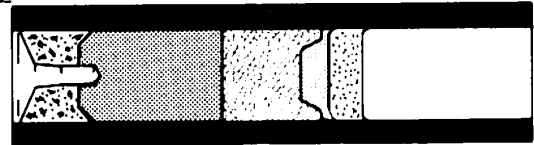

**Ohm's Law:**

Established in 1827 by physicist George Simon Ohm and states the practical unit of electric resistance (1 ohm) is equal to the resistance of a circuit in which a potential difference of one volt produces a current of one ampere.

**Parachute:**

A drag-producing device, generally hemispherical (half-sphere) in shape. Parachutes used in model rockets are generally made from light plastic and are used to gently recover the payload package, rocket body, etc.



**PARACHUTE ASSEMBLY**

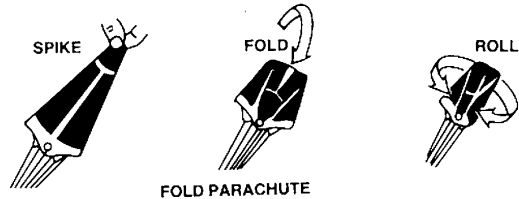

WRAP SHROUD LINES LOOSELY AROUND PARACHUTE  
INSERT PARACHUTE  
IN ROCKET

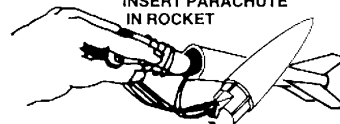

INSTALL NOSE CONE IN PLACE

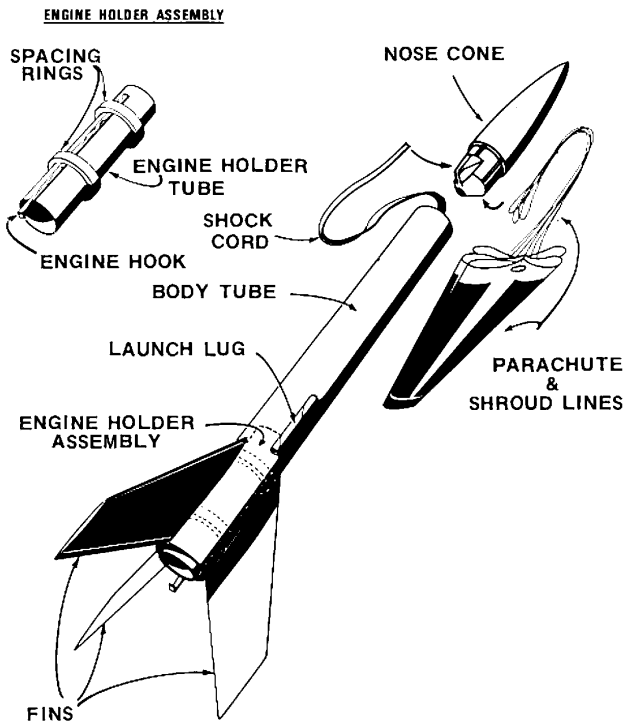

**Payload Section:**

The section of the rocket used to carry instruments, biological specimens, etc. This is usually either a spiral wound cardboard tube or clear plastic tube.

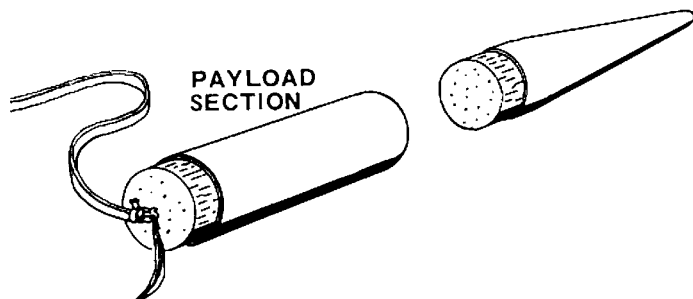

**Peak Thrust:**

The greatest amount of thrust developed by a rocket engine during its firing.

**pound-second:**

A measure of the total impulse produced by a rocket engine.

**Powered Flight:**

The early flight phase when the model rocket engine is providing thrust.

**Recovery System:**

A device incorporated into a model rocket for the purpose of returning it to the ground in a safe manner. All model rockets must employ a recovery system (such as a parachute).

**Recovery Wadding:**

Flame resistant tissue packed between the streamer or parachute and model rocket engine protecting the recovery device from hot ejection gases.



**Resistance, Electrical:**

The opposition offered by a body or substance to the passage of a steady electric current through it.

**Root Edge:**

The point at which the fin or wing is attached to the body tube.

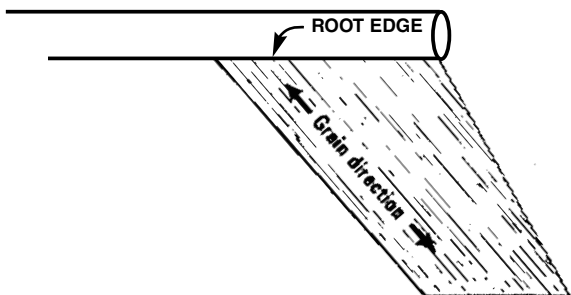

**Model Rocketry Safety Code:**

Code establishing rules for safe conduct in model rocketry.

**Safety Key:**

Special key used to activate a launch system.

**Screw Eye:**

Metal eye screw, anchored in nose cone or payload compartment base, used to attach parachute and shock cord.



**Shock Cord:**

The elastic cord used to attach the recovery system to the body of the rocket. Its elasticity absorbs shock when the recovery system deploys.

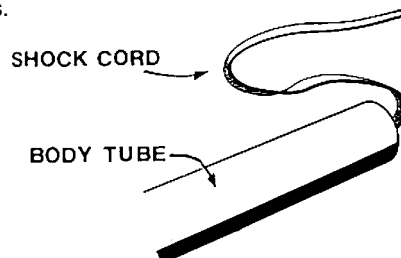

**Shroud Line:**

The string or cord used in making parachutes.

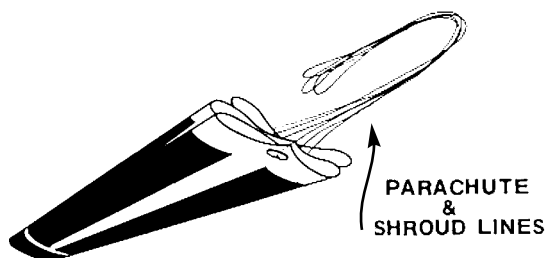

**Snap Swivel:**

Used to attach parachute or shock cord and allows parachute to be changed quickly from one rocket to another.



**Specific Impulse:**

A measurement for determining the relative performance of rocket propellants; the measure of energy content per pound of propellant.

**Sustainer Engine:**

Single or upper stage engine equipped with a delay element and an ejection charge.

**Throat:**

The portion of a rocket engine nozzle having the smallest cross-sectional area.

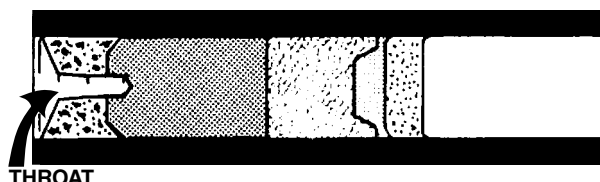

**Thrust:**

The propulsive force developed by an operating rocket engine caused by the rearward ejection of gases during the combustion process.

**Time-Thrust Curve:**

A graphic expression of the relation between thrust produced by a rocket engine and time; a graph showing the thrust produced by a rocket engine at each instant of its operation.

**Tip:**

The outermost end of a fin.

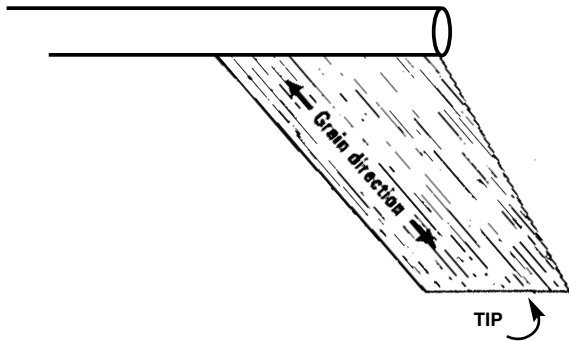

**Total impulse:**

The total amount of thrust developed by a rocket engine; determined by measuring the area under the engine's thrust-time curve; or by multiplying the average thrust by the burning time.

**Touchdown:**

Moment during recovery when rocket makes contact with the earth.

**Trailing Edge:**

The rear edge of a fin or wing surface.

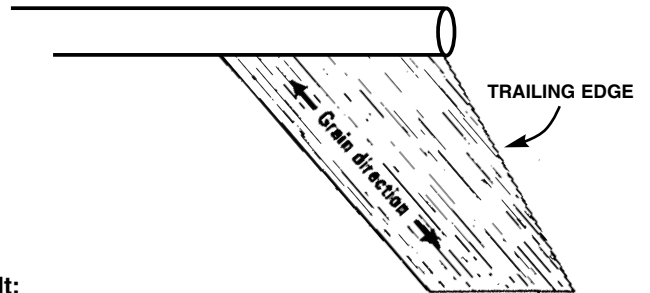

**Volt:**

The unit of electromotive force; the electric potential required to make a current of one ampere flow through a resistance of one ohm.

# NOTES

# SECTION REVIEW

## SECTION I

Review what you have learned in Section I, the Model Rocketry Technical Manual and the Model Rocket Glossary, Part I, before completing this review. Be sure not to look up anything once you start this review. Read the question and pick your answer from the multiple-choice column of answers or write in the proper answer. Good luck!

Identify the flight phases of a model rocket.

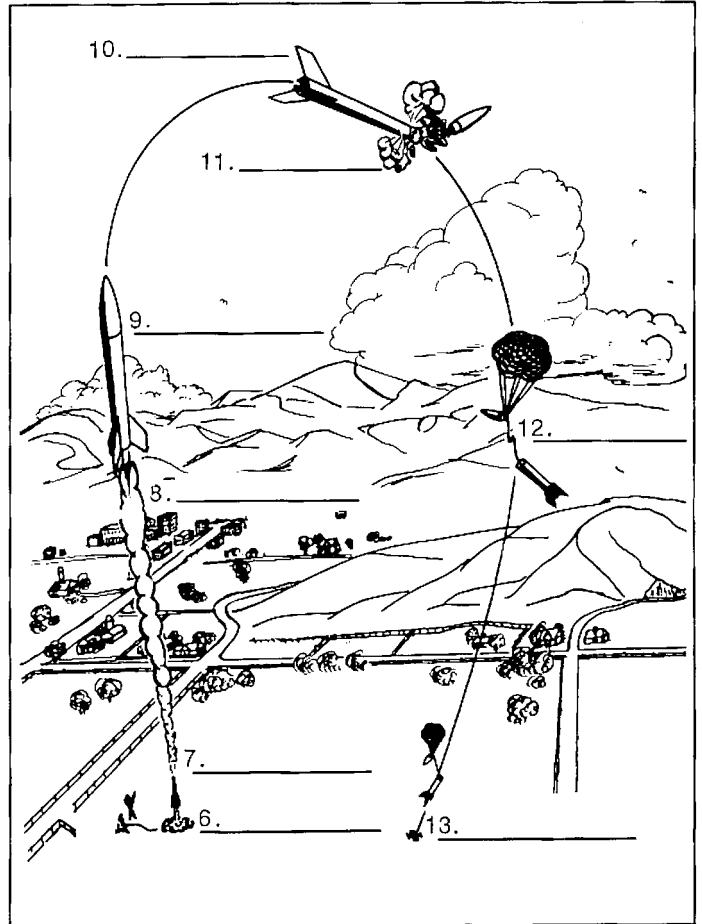

1. My model rockets will be launched with a launch system operated by: \_\_\_\_\_
  - A. matches and fuses
  - B. electricity
  - C. springs
2. Model rockets must weight no more than \_\_\_\_\_ ounces at lift off.
  - A. 4 ounces
  - B. 8 ounces
  - C. 16 ounces
  - D. 32 ounces
3. Always remain at least \_\_\_\_\_ feet from a model rocket that is being launched.
  - A. 5 feet
  - B. 15 feet
  - C. 25 feet
4. To be aerodynamically stable, a model rocket must have its: \_\_\_\_\_
  - A. Center of gravity ahead of its center of pressure
  - B. Center of gravity in the same place as its center of pressure
  - C. Center of gravity behind its center of pressure
5. The total impulse delivered by a B6-4 engine is \_\_\_\_\_ that delivered by a 1/2 A6-2 engine.
  - A. one-half
  - B. equal to
  - C. twice
  - D. four times

14. Engine total impulse may be rated in \_\_\_\_\_.
  - A. newton-seconds
  - B. pounds-seconds
  - C. either newton-seconds or pound-seconds
  - D. neither newton-seconds nor pound-seconds
15. Every launch system must have a safety switch of some type. True or false? \_\_\_\_\_
16. Should you make your own model rocket engines? Yes or no? \_\_\_\_\_

17. Model rockets are made of paper, cardboard tubes, balsa, plastic, steel tubes, and rubber.  
True or false? \_\_\_\_\_

18. Name two other recovery systems besides parachute recovery.  
\_\_\_\_\_ and \_\_\_\_\_

19. After the thrust phase of the flight is over, the rocket is in the \_\_\_\_\_ phase before the ejection charge operates.

Identify the engine parts indicated in the following drawing:

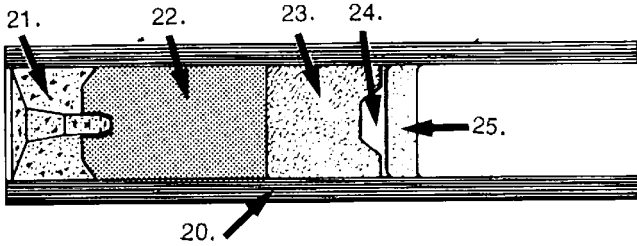

20. \_\_\_\_\_ 21. \_\_\_\_\_

21. \_\_\_\_\_ 23. \_\_\_\_\_

24. \_\_\_\_\_ 25. \_\_\_\_\_

**LABEL THE PARTS:**

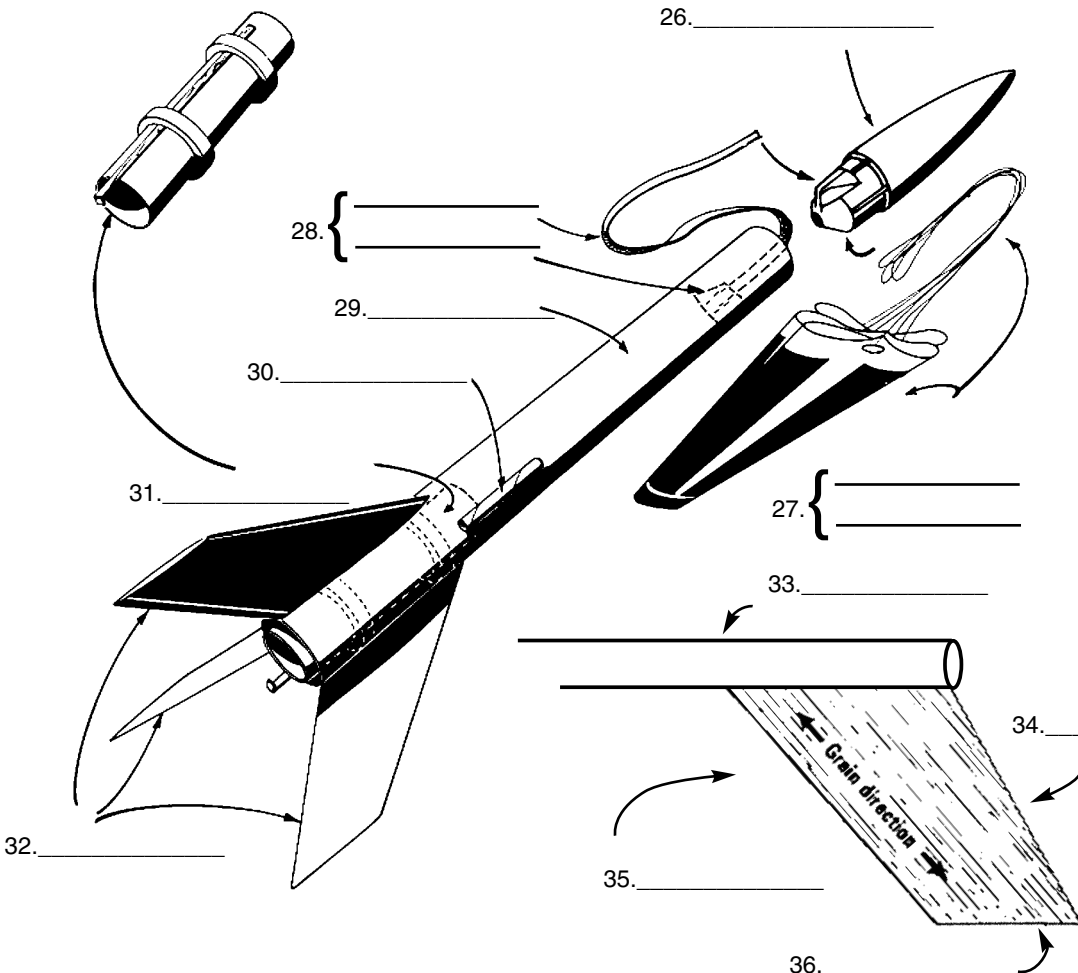

**FIN PART NAMES**

- 37. The point in the orbit of a satellite at which the satellite is farthest from Earth is called the \_\_\_\_\_.
- 38. The portion of a rocket engine nozzle with the smallest cross-sectional area is the \_\_\_\_\_.
- 39. The tiny, flat-jawed alligator clip used to attach the ignition system to the igniter is called the \_\_\_\_\_.
- 40. "For every action there is an equal and opposite equal reaction," is Newton's \_\_\_\_\_ Law.

**ANSWERS**

- 20. Paper casing
- 19. Coast
- 18. Featherweight, tumble, streamer, helicopter, glider
- 17. F
- 16. No
- 15. T
- 14. C
- 13. Recovery
- 12. Parachute deployment
- 11. Ejection charge
- 10. Apogee
- 9. Coast period
- 8. Thrust Phase
- 7. Lift-off
- 6. Ignition
- 5. D
- 4. A
- 3. B
- 2. C
- 1. B
- 21. Nozzle
- 22. Propellant
- 23. Smoke tracking and delay element
- 24. Ejection charge
- 25. Ejection charge retainer
- 26. Nose Cone
- 27. Parachute and shroud lines
- 28. Shock cord and mount
- 29. Body tube
- 30. Launching Lug
- 31. Engine holder assembly
- 32. Fins
- 33. Root edge
- 34. Trailing edge
- 35. Leading edge
- 36. Tip
- 37. Apogee
- 38. Throat
- 39. Micro-clip
- 40. Third

**ANSWERS**

# NOTES

# SECTION II

## ADVANCED MODEL ROCKETRY

Continue your efforts toward becoming an expert rocketeer by following Section II of the Model Rocketry Study Guide. Each new project will advance your knowledge of model rocket science.

**T-10** Learn about model rocket stability by studying Technical Report TR-1, "Rocket Stability" (The Classic Collection EST 2845). By using the methods and techniques suggested, you will be assured of safe and stable flights. Pre-flight stability tests, such as the swing test will contribute to your experience and will be of later value in testing rockets of your own design.



**T-9** Read Technical Note TN-1, "Model Rocket Engines" (The Classic Collection EST 2845) and TN-2, "Model Rocket Engine Performance" to gain a better understanding of how the various types of model rocket engines function. Make several flights of a single stage Estes® model rocket using different types of engines and compare the flights. The information gained from your observations will be of future assistance when you are ready to launch models of more advanced designs.

**Typical Time/Thrust Curve  
B8-5 Series II**

Exhaust Velocity - 2550-2650 ft. / sec.  
Specific Impulse - 80-83 lb.-sec. per lb.

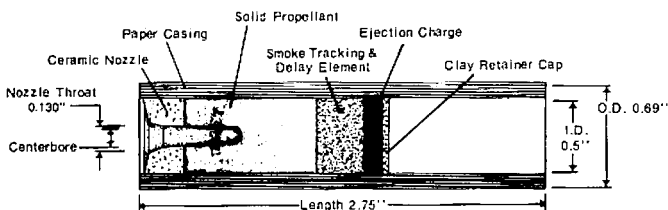

**COMPARATIVE TIME/THRUST CURVES**

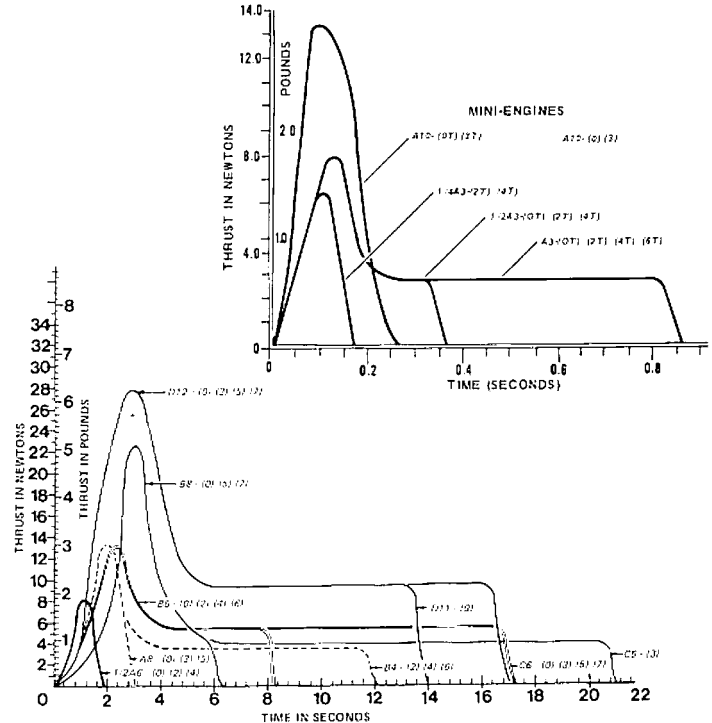

**T-8** For maximum altitude and performance, build a multi-stage vehicle, study Technical Report TR-2, "Multi-Staging" found in The Classic Collection. Learn about booster engines, stage-to-stage coupling, in-flight ignition and reliable separation.





Don't forget to follow the assembly and flight instructions carefully. Be sure to launch your model from an area with a large recovery field as staged rockets can attain tremendous heights.

Once you have mastered altitude tracking, your data reduction operations can be improved with flight sheets, computers, stop watches and walkie-talkies.



**T-7** To find out how high your rockets go, read Technical Report TR-3, "Altitude Tracking" ([The Classic Collection](#) EST 2845). This report will show you how to perform accurate tracking and altitude determination. Build an Altitrak™ or construct a tracking device from your own supplies. Launch several rockets and determine their altitudes through either single station or two-station tracking.

**T-6** Explore the potential of using clusters of engines for increased power. Study Technical Report TR-6, "Cluster Techniques" from [The Classic Collection](#) and learn about the various engine cluster configurations and cluster ignition techniques.



Design, construct, stability test and fly a cluster-powered rocket, which features a two or three engine cluster.



**T-5** Now that you have experience in single stage construction, multi-staging and cluster techniques, construct and fly a payload rocket using one of these propulsion systems. Choose your payload first, then select the type of rocket needed to launch it.



Single and multi-stage rockets that feature a payload compartment are excellent for insect payloads. Cluster rockets are especially suited for lofting a large cargo such as a raw egg. Some models can be used to carry aerial cameras.

The mighty Estes "D" engine has the capability for carrying large, heavy payloads to extremely high altitudes. You should consider this "workhorse" when planning your payload project. For complete information on the "D" engine refer to the current Estes catalog and to the engine instructions packed in each "D" engine package.



When constructing your payload vehicle take special care in preparing and protecting the all-important payload from possible acceleration or recovery damage. Remember to launch your rocket from an area with a large recovery field to assure the prompt return of your payload.



**T-4** Scale model rocketry involves the design and construction of miniature rockets which are replicas of full-sized rockets. Scaling is one of model rocketry's most challenging and rewarding areas and requires patience, attention to detail, craftsmanship and desire.



Build and fly a skill level 2 or 3 scale model kit. As your skill increases build skill level 4. After successfully completing this project, you can attempt your own scale project. Choose a real rocket or missile for scaling, then write to its manufacturer for dimensions, plans, pictures, paint pattern and flight substantiation. By carrying out such a project you will obtain a great deal of experience and much satisfaction.



### T-3

Model rocket competition is one of the most exciting forms of model rocket activity. Read the Model Rocket Contest Guide EST 2815, and learn about maximum altitude, parachute duration, glide duration, drag racing, spot landing, set altitude, payload handling, scale, craftsmanship and research and development events.



Construct and fly a high performance competition model and compare its altitude and duration times to other single stage rockets using the same type of engine.



### T-2

Learning how to design your own rockets is one of the most important steps to becoming an expert rocketeer. You have built and flown various types of model rockets and are ready to develop your own designs. Read Technical Report TR-1 and Technical Report TR-11 to learn about center of gravity and center of pressure calculations, nose cone shapes, fin area determination and other stability concepts.



When launching a rocket of your own design be sure to follow the rules in the "Model Rocketry Safety Code" which deals with the testing of unproven designs or methods.

- "12. Pre-Launch Test - When conducting research activities with unproven designs or methods, I will, when possible, determine their reliability through pre-launch tests. I will conduct launchings of unproven designs in complete isolation from persons not participating in the actual launching."

Remember, data reduction is very important to design testing as it can be reviewed for future reference.

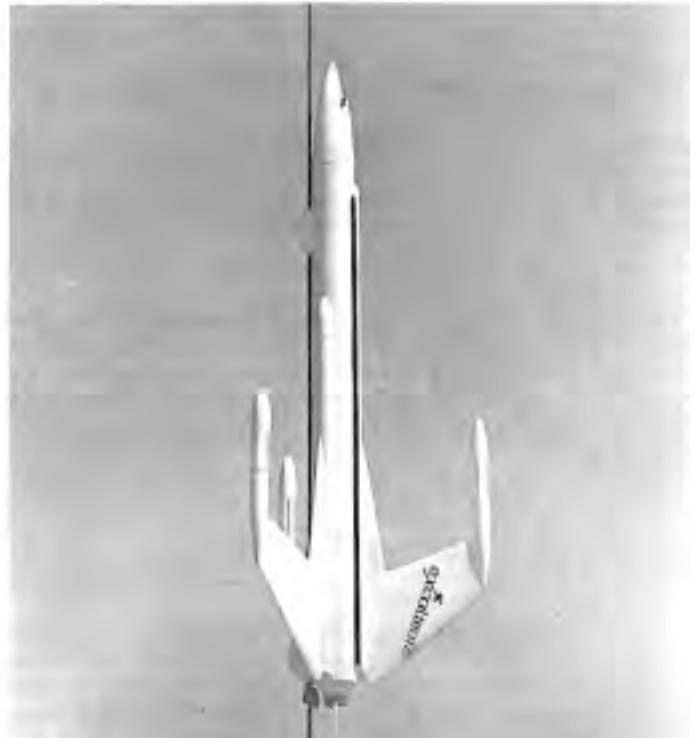

# T-1

Your model rocket activities can now advance in many directions. As you continue on the road to becoming an expert rocketeer you may wish to explore the following areas.

- a. Weather and atmospheric tests  
(Remember not to launch when visibility is poor.)

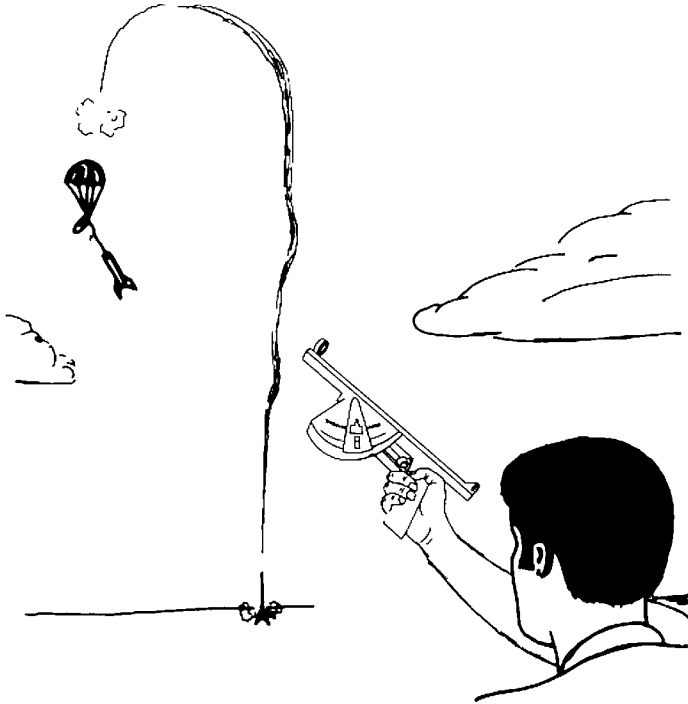

- b. Studies in the mathematics of rocket flight including investigations in acceleration, trajectory, drag, etc. Refer to Technical Reports TR-10, Altitude Prediction Charts EST 2842 and TR-11, Aerodynamic Drag of Model Rockets EST 2843.



- c. Construction of a static test stand to secure time-thrust curve information for various types of model rocket engines. Full plans are provided in Estes Educator News, Spring-Summer 1980 for one type.

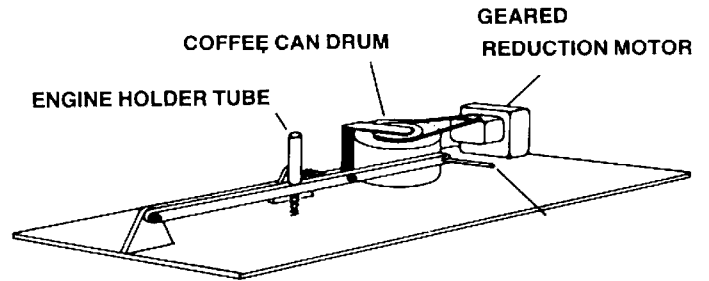

- d. Construction of a wind tunnel for pre-flight stability tests. Refer to Technical Report TR-5, "Building A Wind Tunnel" found in The Classic Collection EST 2845.

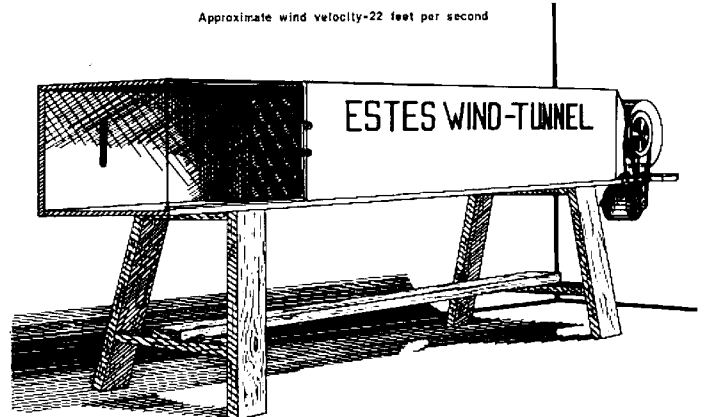

- e. Development of new types of recovery devices.

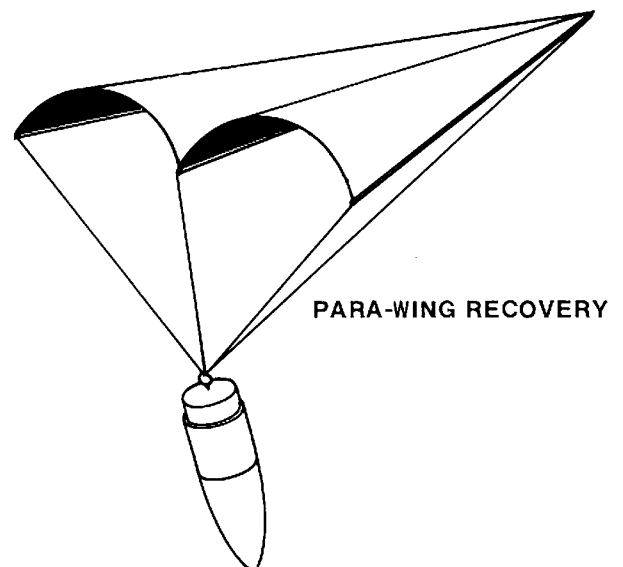

f. Photo interpretation using the AstroCam™



3-Mile Island



Goddard Space Flight Center



Warren, MI

g. Construction of a model rocket gantry or launch tower.



h. Construction of an underwater launch facility.



i. Payload experimentation using insects. Take the greatest care possible for the passenger's safety, comfort and well being.

j. Development of a two station, 3-dimensional tracking system and the construction of theodolite tracking devices.



k. Conduct full-fledge research and development programs into previously unexplored areas of model rocket science.

# NOTES

## ADVANCED TERMS

**Acceleration:**

The rate of increase in the speed of an object. Acceleration is generally measured in terms of "g's", one "g" being the rate at which a dropped object accelerates under the force of gravity, or 32.2 feet per second per second.

**Accelerometer:**

A device for the measurement of acceleration.

**AltiTrak™:**

Device used to determine the elevation angle of a model rocket which is used to calculate the altitude of a model rocket.

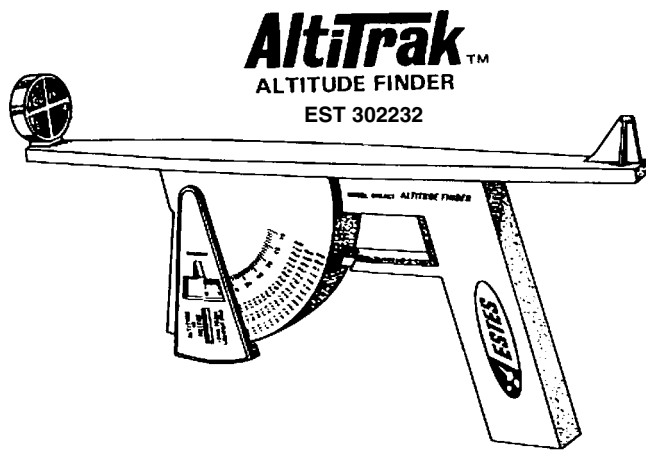

**Azimuth Angle:**

A direction expressed as a horizontal angle from a given reference point.

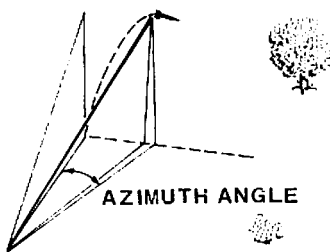

**Balsa Adapter:**

Round tapered balsa fitting used to connect body tubes of different diameters.

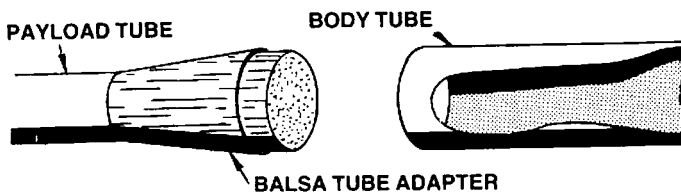

**Barrowman Method:**

Mathematical method used to calculate the center of pressure of a model rocket.

**Base Line:**

Distance between the tracker and the launch pad in single station tracking or the distance between tracker # 1 and tracker # 2 in two-station tracking.

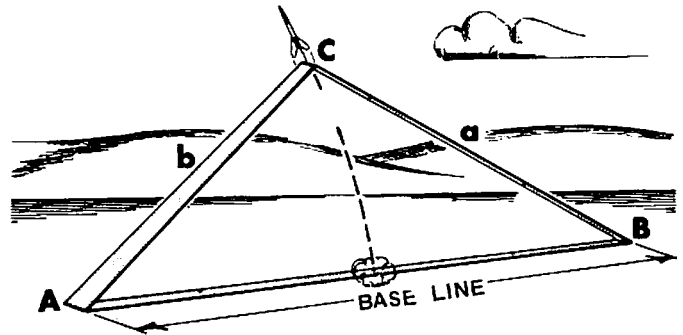

**Blow-through:**

An engine failure in which the propellant is blown out the forward end of the casing. Lower stage engines have a certain amount of blow-through designed in them to provide hot gases for the ignition of the next stage.

**Booster:**

A separate, detachable portion of a rocket containing its own engine; used to impart an initial velocity to the rocket before the ignition of the upper stage engine of the rocket. The booster separates from the rocket when the next engine is ignited. For further information, see Technical Report TR-2 found in [The Classic Collection](#).

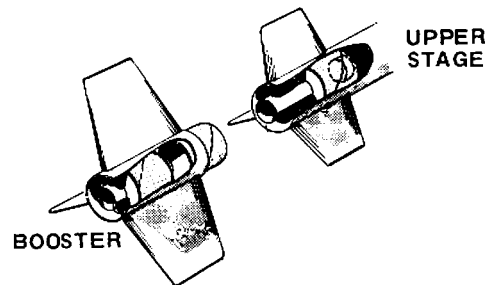

**Burnout Velocity:**

The speed of a rocket at the time all propellant has been totally consumed.

**Burnout Weight:**

The weight of a model rocket after all propellant has been expended.

**Buss Bar:**

Length of low resistance wire to which igniters are attached for the parallel or cluster ignition of engines.





**Center of Pressure:**

The center for all external aerodynamic forces on the complete rocket including the body and fins.

**Chamber Pressure:**

The pressure exerted on the walls of the combustion chamber of a rocket engine by the burning propellant gases; usually measured in pounds per square inch.

**Clip Wire:**

Micro-clip assembly used to ignite a cluster of engines.

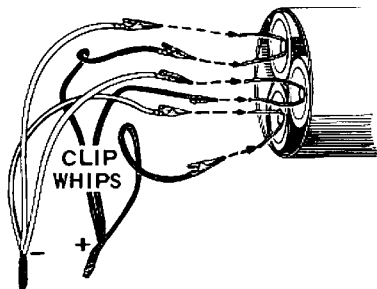

**Cluster:**

A group of rocket engines which work as a unit. The total thrust of a clustered unit is equal to the thrust of all the individual engines added together.

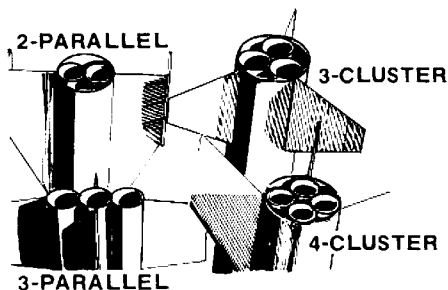

**Configuration:**

The external form or contour.

**Data Reduction:**

Process of calculating the performance of a model, such as its peak altitude or its flight duration.

**Deceleration:**

The rate of decrease in the speed of an object. Deceleration is generally measured in "g's".

**De Laval Nozzle:**

The nozzle used in high performance rocket engines consisting of three separate sections; a convergent section; a throat section; and a divergent section.

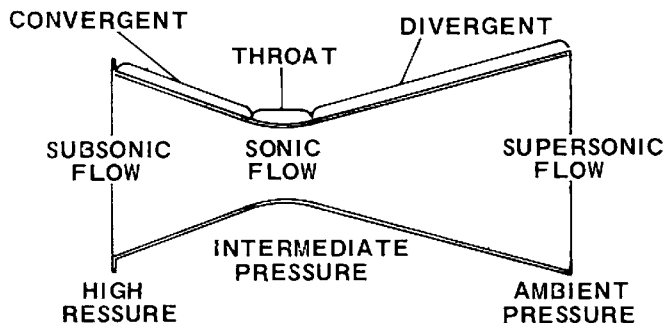

**Drag:**

Aerodynamic forces acting to slow an object in flight. Because of their low weight to area ratio and high velocities, model rockets are especially susceptible to these forces.

**Drag Racing:**

Competition in which two competitors race their rockets against each other. Points are distributed as follows: First off the pad receives one point, lowest altitude receives one point and last down receives one point. The competitor achieving at least two points wins.

**Ducted Ejection:**

Method of ducting ejection gases through tubes to a particular area; system of ducting hot ejection gases until they are cool before initiating the deployment of the recovery device. Eliminates the need for recovery wadding.

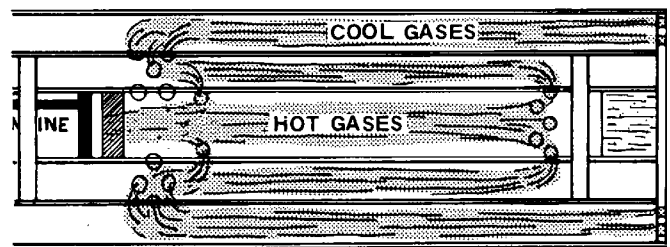

**Elevation Angle:**

Vertical angle recorded by trackers used to compute the altitude of a model.

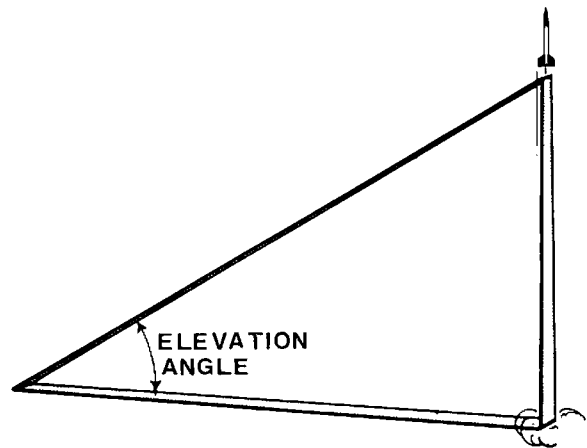

**Exhaust Velocity:**

The speed of the exhaust gases of a rocket engine.

**Flight Duration:**

The length of time during which a model rocket is airborne.

**Flight Substantiation:**

Official data stating the proven flight characteristics of a NASA vehicle or other professional rocket.



**Gantry:**

A crane-like structure with platform on different levels used to erect, assemble and service large rockets or missiles. It is located next to the missile or rocket during launch preparation, but is rolled away before firing.

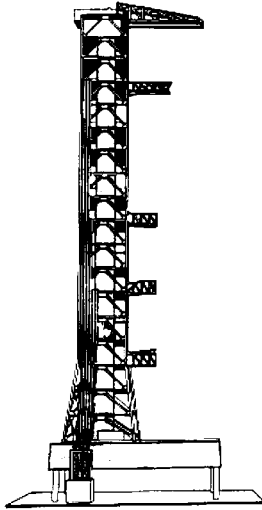

**Horizontal:**

Level or parallel to the horizon.

**Krushnik Effect:**

The loss of effective thrust from a model rocket engine occurring when the engine is recessed forward in the body tube more than one diameter of the body.

**Launch Rail ("C" rail):**

Metal rail with a hollow square shape; its cross section forming a squared C; used to guide a model during its first few feet of flight until stabilizing velocity is reached.

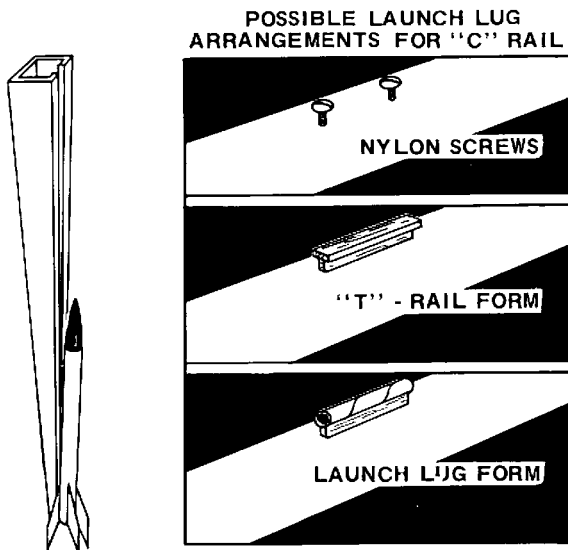

**Loaded Weight:**

The weight of a model rocket with loaded engine, igniter, wadding and recovery device.

**Mach Number:**

The ratio of the speed of an object to that of sound in the medium being considered. At sea level in air at the normal atmospheric pressure a body moving at a Mach number of one (Mach 1.0) would have a velocity of approximately 1100 feet per second, the speed of sound in the air under those conditions.

**Maximum Altitude:**

Competition in which participants, using the same type engine, attempt to send their rockets to the highest altitude possible.

**Metric System:**

International system of weights and measurements.

**Moment:**

Determined by multiplying force by distance from a reference point.

**Momentum:**

A property of a moving object equal to its velocity times its mass.

**Multi-State Rocket:**

A rocket having two or more engines, each used during a different portion of the flight, each stage being dropped as soon as its engine has been exhausted.

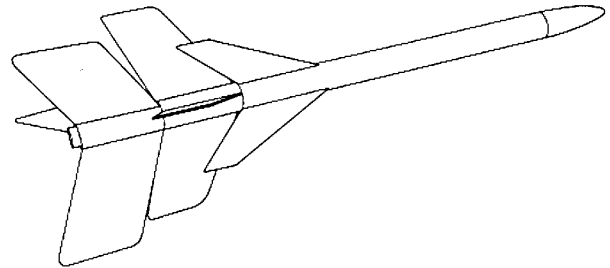

**National Association of Rocketry, N.A.R:**

Founded in 1957 to perpetuate individual and organized model rocketry, to develop standards and safety codes to establish standardized competition and to sponsor national championships.

**Nose Block (Bulkhead):**

Round balsa fitting used to block off a payload section or body tube.

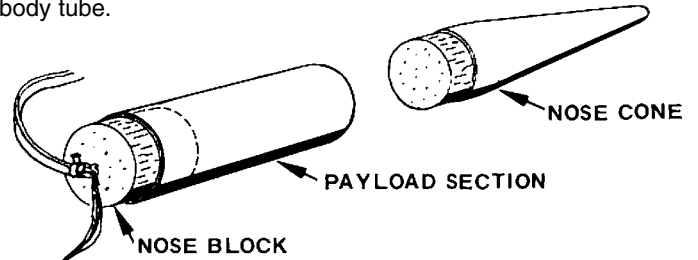

**Nozzle Blow:**

A model rocket engine failure in which the nozzle is forcibly expelled from the rear of the engine.

**Parallel Ignition:**

Method of simultaneously igniting two or more engines in a cluster.

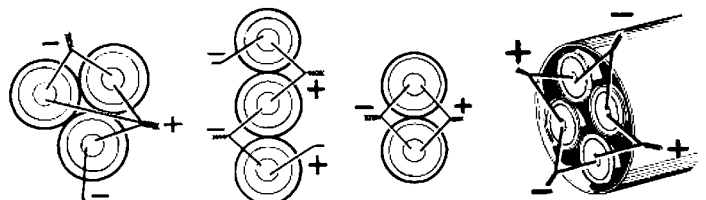

**Payload:**

The load to be lifted by the rocket, usually not a functioning part of the rocket.

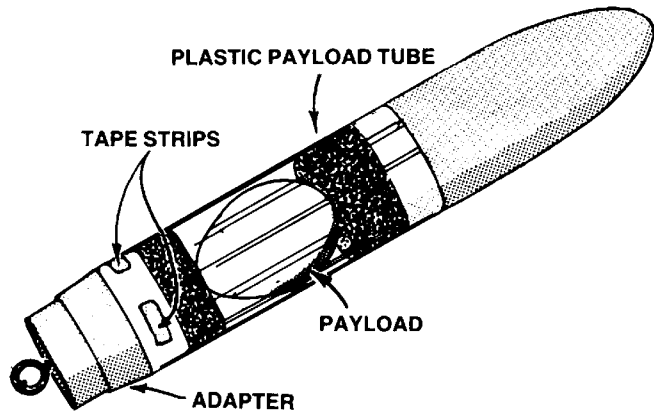

**Payload Handling:**

Competition in which participants attempt to launch payload-carrying rockets to the highest altitude possible and to bring the payload back undamaged.

**Pitch:**

Rotational movement around the lateral axis of the craft.

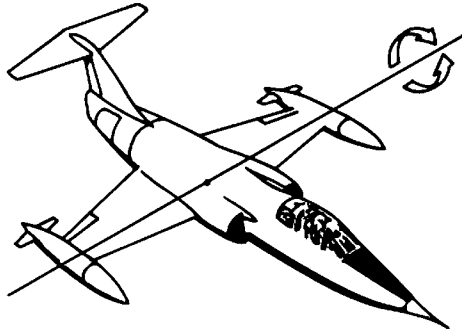

**Professional Rocket:**

NASA vehicle or rocket built by government agency, aerospace industry or professional scientists.

**Propellant Weight:**

The weight of the propellant in a rocket engine.

**Propulsion:**

Act of propelling or of driving forward.

**2-D (Quickie) Computer:**

Two-dimensional computer for quick calculations or altitude using elevation angles.

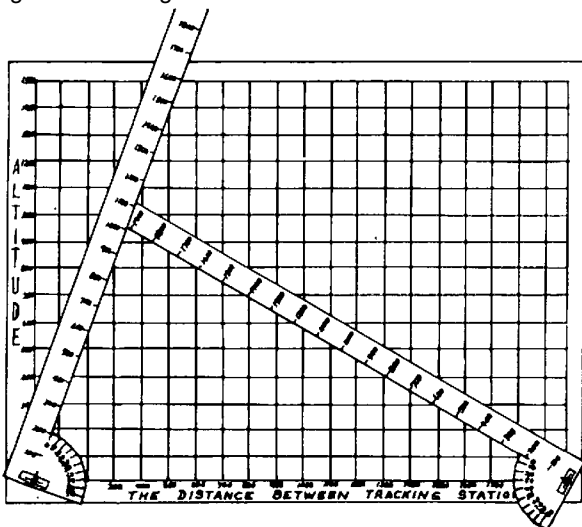

**Research & Development (R&D):**

Process of planned experimentation leading toward a predetermined goal or a competitive event in which participants present special R & D projects.

**Reynolds Number:**

A correction factor applied to analysis of the fluid flow about scale models used in wind tunnel tests to determine the results which are to be expected of the flow about full-scale models; a dimensionless ratio. (See TR-11 for more information.)

**Rocketus Eatumopus:**

Tree or large shrub, which catches and "eats" model rockets.

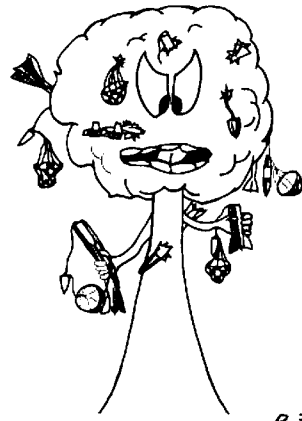

*The Rocketus eatumopus*

**Roll:**

Rotational movement of a craft about its longitudinal axis.

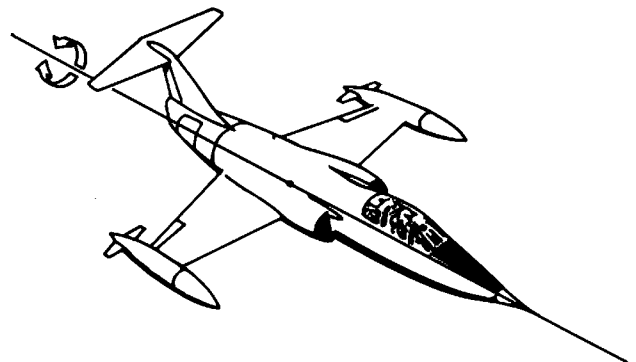

**Scaling:**

Process of making a plan for a model which is a precisely detailed replica of the full-sized original.

**Set Altitude:**

Competition in which the participant predicts the altitude his rocket will reach.

**sine:**

The trigonometric function that for an acute angle in a right triangle is the ratio of the side opposite the angle to the hypotenuse.

**Single Station Tracking:**

Tracking system employing only one tracker. It is the least expensive and accurate of the tracking methods.

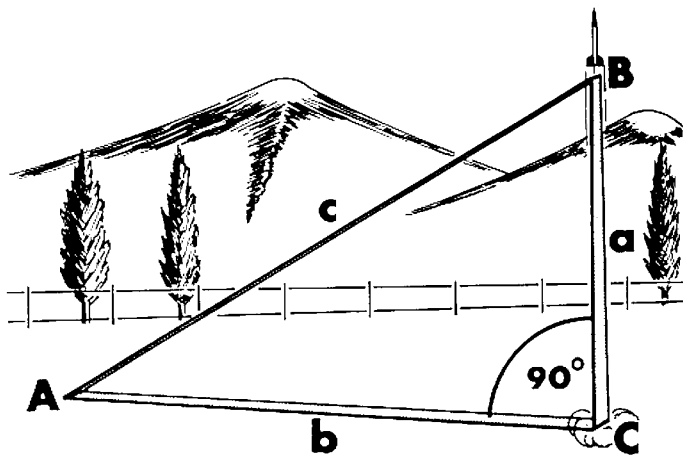

**Solid Propellant:**

The mixture of fuel and oxidizer in solid form which burns to produce the hot gases used in generating thrust.

**Sounding Rocket:**

A research rocket used to obtain data on the upper atmosphere.

**Spot Landing:**

Competition in which the participant attempts to have his rocket touch down at a predetermined spot.

**Stability, Inherent:**

The tendency of a rocket having the proper center of gravity/center of pressure relationship to maintain a straight course despite rotating forces caused by variations in design and outside disturbances.

**Stage Coupler:**

Tubing used to temporarily attach one stage to another.

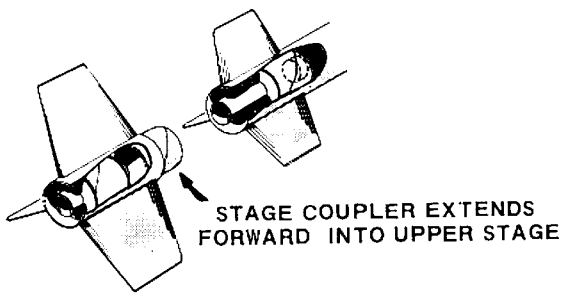

**Static Firing:**

A test of a rocket engine in which the engine is restrained from leaving the ground. Static firings are conducted for the purpose of determining an engine's performance and reliability characteristics.

**Static Test Stand:**

Device used to measure an engine's performance and reliability characteristics and or generating a thrust-time curve.

**Streamer:**

Recovery system made from a narrow piece of flame-resistant crepe paper or plastic.

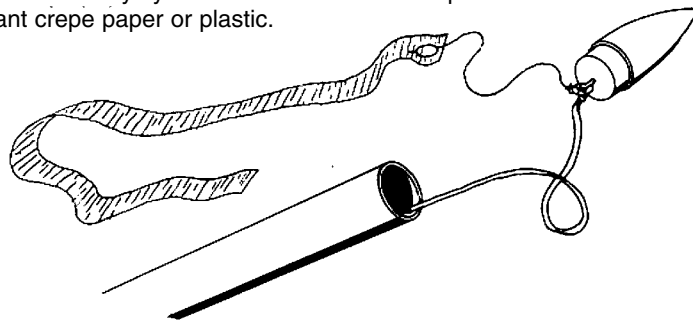

**Stuffer Tube:**

A smaller tube placed inside a larger body tube used to duct ejection gases to a particular area.

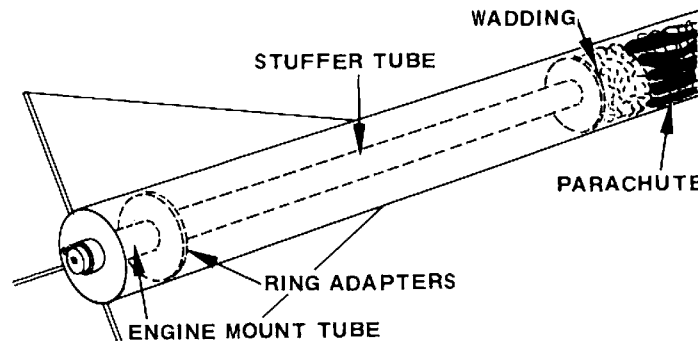

**Summation:**

The sum total or aggregate.

**Swing Test:**

Simple, pre-flight test to check the stability of a model rocket.

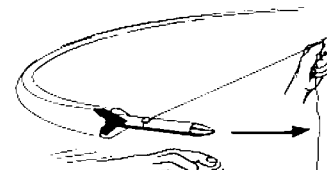
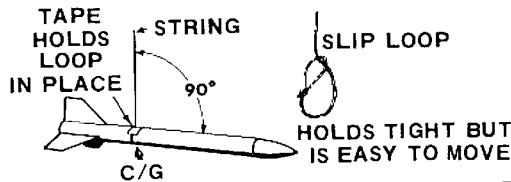

**Tail cone (boat-tail):**

Cone-shaped balsa or paper fitting extending from the rear end of the body tube to the engine mount, reducing body tube diameter of the engine. Used to decrease drag.

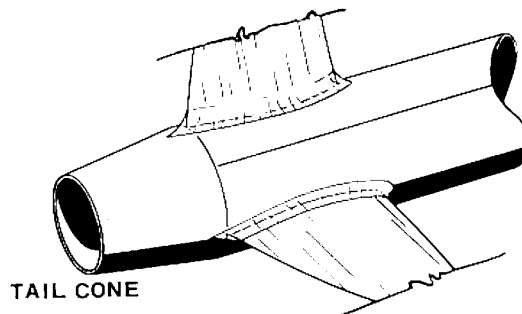

**Tangent:**

The trigonometric function that for an acute angle in a triangle is the ratio of the side opposite to the side adjacent.

**Telemetry:**

The science of sending data from a rocket back to earth.

**Theodolite:**

An optical instrument for measuring horizontal and/or vertical angles with precision.

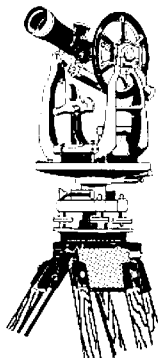

**Three-Dimensional Tracking:**

Two station tracking system measuring both elevation and azimuth angles. This is the most accurate type of tracking system.

**Thrust Duration:**

The length of time during which a model rocket produces thrust.

**Trade-Offs:**

Compromises made in model rocket design involving weight, diameter and drag.

**Trajectory:**

The path followed by a ballistic object. Strictly speaking, a model rocket does not follow a trajectory as its direction and rate of travel are strongly influenced by atmospheric conditions.

**Two-Station Tracking:**

Tracking system employing two trackers. It is more accurate than single station tracking.

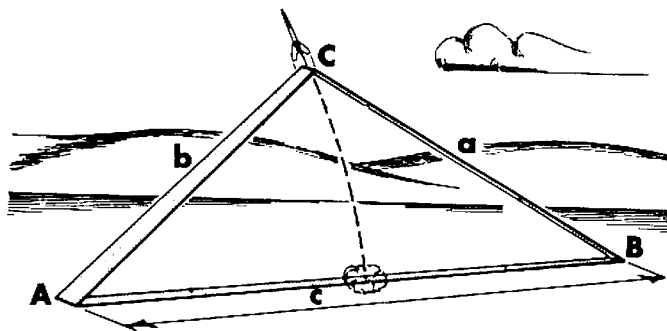

**Velocity:**

Speed or rate of motion.

**Vertical:**

At right angles to the horizontal

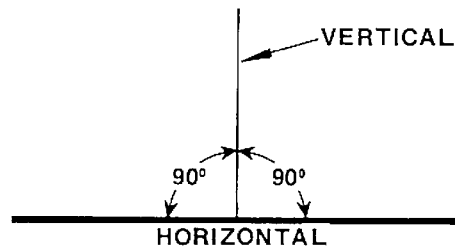

**Weathercock:**

To turn into the wind away from a vertical path.

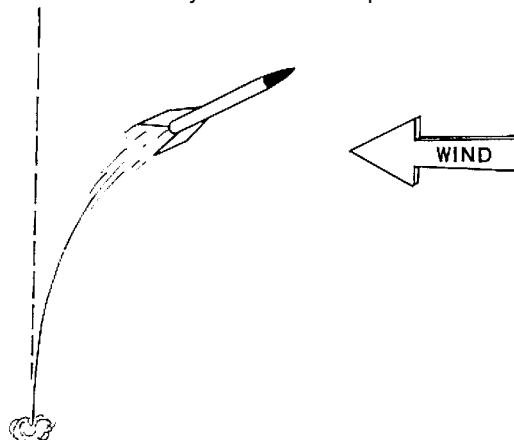

**“Whatchamacallit”:**

Any object for which a rocketeer cannot remember the name.

**Wind Tunnel:**

Device used to test the stability and flight characteristics of various aerodynamic structures.

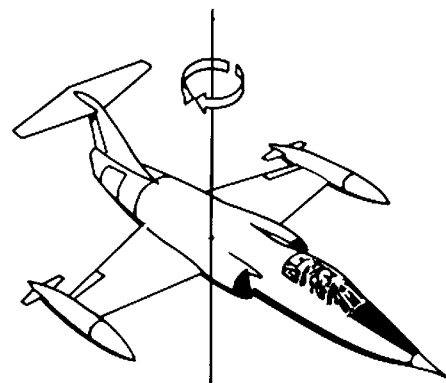

**Yaw:**

Rotation of a craft about its vertical axis.

# SECTION REVIEW

## SECTION II

Review what you have studied in Section II and study the Model Rocket Glossary, Part II, before you begin this review. Do not look up anything once you start the review. Good luck!

- The rocket's center of gravity should be: \_\_\_\_\_
  - Behind its center of pressure
  - In the same place as its center of pressure
  - Ahead of its center of pressure
- A C6-3 engine has a total impulse \_\_\_\_\_ as great as that of a 1/2 A6-2 engine.
  - the same
  - one-half
  - four times
  - eight times
  - sixteen times
- A C6-3 engine has a total impulse of \_\_\_\_\_ newton-seconds.
  - 0.625 newton-seconds
  - 1.25 newton-seconds
  - 2.50 newton-seconds
  - 5.00 newton-seconds
  - 10.00 newton-seconds
  - 20.00 newton-seconds
- A C6-3 engine has a delay element which operates for \_\_\_\_\_ seconds after the rocket's engine has stopped producing thrust.
 

A8-0  
A10-3T  
B4-2  
B4-4  
B6-0  
C6-0  
D12-0  
D12-5

- Multi-stage model rocket's last stage must be stable but it is not necessary for the entire rocket to be stable before launch. True or false? \_\_\_\_\_
- Calculate the height of this model rocket at point B. \_\_\_\_\_ feet.

Given: baseline  $b = 300$  ft.  
 $\angle A = 31^\circ$

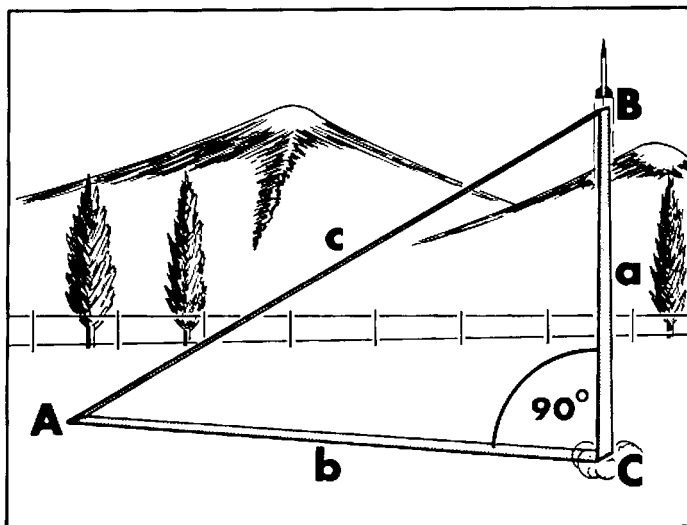

TABLE OF TANGENTS

ANGLE	TAN.	ANGLE	TAN.	ANGLE	TAN.
1°	.02	28°	.53	54°	1.38
2°	.03	29°	.55	55°	1.45
3°	.05	30°	.58	56°	1.48
4°	.07	31°	.60	57°	1.54
5°	.09	32°	.62	58°	1.60
6°	.11	33°	.65	59°	1.66
7°	.12	34°	.67	60°	1.73
8°	.14	35°	.70	61°	1.80
9°	.16	36°	.73	62°	1.88
10°	.18	37°	.75	63°	1.96
11°	.19	38°	.78	64°	2.05
12°	.21	39°	.81	65°	2.14
13°	.23	40°	.84	66°	2.25
14°	.25	41°	.87	67°	2.36
15°	.27	42°	.90	68°	2.48
16°	.29	43°	.93	69°	2.61
17°	.31	44°	.97	70°	2.75
18°	.32	45°	1.00	71°	2.90
19°	.34	46°	1.01	72°	3.08
20°	.36	47°	1.07	73°	3.27
21°	.38	48°	1.11	74°	3.49
22°	.40	49°	1.15	75°	3.73
23°	.42	50°	1.19	76°	4.01
24°	.45	51°	1.23	77°	4.33
25°	.47	52°	1.28	78°	4.70
26°	.49	53°	1.33	79°	5.14
27°	.51			80°	5.67

8. To launch a model rocket which is powered by a cluster of engines, the igniters should be attached to the ignition system in \_\_\_\_\_.  
A. series  
B. parallel
9. A cluster of four B6-4 engines will produce \_\_\_\_\_ times as much total impulse as a cluster of two A8-3 engines.
10. When building your payload-carrying rockets to use D engines, the model should be made very strong to safely withstand the thrust developed by D engines. The Estes D engine fits snugly inside a BT- \_\_\_\_ body tube.
11. When launching live insects as passengers in payload-carrying model rockets, every care should be taken to provide for the passenger's comfort and safety, and the launch should not be made unless there is valid scientific reason for it.  
  
True or false? \_\_\_\_\_
12. In a Drag Race, one point is awarded to the rocket reaching the ground first.  
  
True or false? \_\_\_\_\_
13. Using a series of engines fired in sequence with each engine and its fin unit dropping off as soon as that engine's propellant is used up is called \_\_\_\_\_.
14. The first letter or number and letter combination for model rocket engine classification indicates the \_\_\_\_\_ of the engine.
15. Which will cause a given model rocket to accelerate faster, a B8-5 or a B4-6 engine? \_\_\_\_\_.
16. The rate at which an object changes speed is called its \_\_\_\_\_.
17. The distance between the tracker and the launch pad in single station tracking is called the \_\_\_\_\_.
18. A solid propellant is composed of a mixture of \_\_\_\_\_.  
  
And \_\_\_\_\_ in solid form.
20. Velocity is \_\_\_\_\_.
21. The momentum of a moving object is equal to its \_\_\_\_\_  
  
Times its \_\_\_\_\_.
23. Yaw is rotation about the \_\_\_\_\_ axis.
24. The speed of a rocket at the time all of its propellant has been used is called the \_\_\_\_\_.
25. The loss of effective thrust from a model rocket engine which occurs when the engine is recessed forward in the body tube more than one diameter of the body is called the \_\_\_\_\_.

## ANSWERS

13. Multi-staging or staging
12. F
11. T
10. BT-50
9. four
8. b
7. 180 feet
6. F
5. A8-0, B6-0, C6-0, D12-0
4. Three
3. E
2. D
1. C
14. Total impulse or power
15. B8-5
16. Acceleration
17. Base line
18. Fuel
19. Oxidizer
20. The speed or rate of motion
21. Mass
22. Velocity
23. Vertical
24. Burnout velocity
25. Krushnik effect

## ANSWERS



# NOTES

# SECTION III

## BOOST - GLIDERS

Not all model rockets look like rockets, some appear to be airplanes. The design and construction of model rocket gliders or boost-gliders provides one of the most challenging areas of model rocket activity. Continue your efforts toward becoming an expert rocketeer and learn the skills of boost-glider modeling by following Section III of the Model Rocketry Study Guide.

**T-3** Learn the basic concepts of model rocket boost gliders by reading Technical Report TR-4, "Rear Engine Boost Gliders", EST 2830. Construct and fly a rear engine boost glider to gain the knowledge and skills necessary for proper trimming. Follow all safety rules.



**OR** Study the Technical Report TR-7, "Front Engine Boost-Gliders", (The Classic Collection) to learn more about advanced principles of boost-glider design. Construct and fly a front engine boost glider and compare its duration times with those of the rear engine boost glider.



**OR** Continue your boost-glider activities with the construction of a pop-pod boost-glider. This type of glider is propelled by a power pod that separates at apogee and returns on its own parachute. The airframe returns by gliding.





**T-2** Now that you have constructed and flown rear engine, front engine and pop pod boost gliders, design your own boost-glider using the principles and techniques gained from past experience. The testing of various methods, designs and material will greatly expand your knowledge of the physics of flight. The developments made in the field of boost-gliders contribute to the entire art of model rocketry. Your research might be on internally contained wings. Rogello wings, flex-wing gliders or on a totally new concept.



**T-1** This project is optional as it requires a high degree of skill in craftsmanship and rather expensive construction costs. By carrying out this project you will participate in the most exciting and advanced area of model rocket boost-glider activity. Assemble and fly a model rocketry multi-channel radio-controlled glider with a friend or as a club project.



## NOTES

## GLIDER TERMS

**Airframe:**

The structure of an aeronautical device; the form that gives the vehicle its shape and strength; usually includes fuselage, wings and flight control surfaces, but does not include engines.

**Airflow:**

The movement of air across a surface.

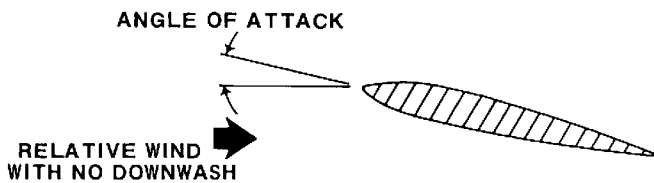
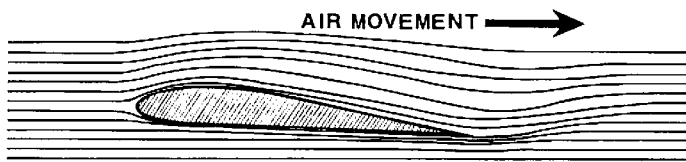

**Aspect Ratio:**

The relationship of the wing span length to the wing chord expressed numerically by the number of times the span can be divided by the chord (straight line drawn connecting leading and trailing edges of an airfoil).

**Bernoulli's Law:**

Established by Swiss physicist Daniel Bernoulli and states that when the velocity of a fluid (as air) is increased (as by flowing around an airfoiled surface) the lateral (sideways) pressure exerted by the fluid is decreased; a wing produces lift by the pressure difference between the air flowing over its upper surface and the air flowing beneath its lower surface.

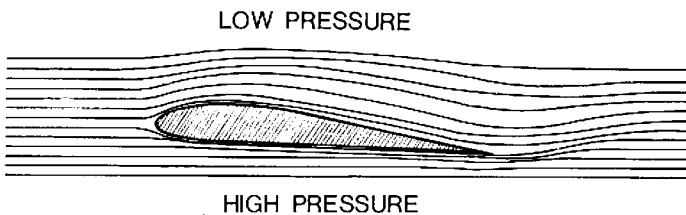

**Boost-Glider:**

It is a combination rocket and glider; the rocket engine provides thrust to launch the glider that returns slowly to the ground by an aerodynamic glide; a parasite which rides on another vehicle (a rocket) for the launch phase and, near apogee, jettisons from its powered unit and glides back to earth; the glider has wings airfoiled to provide aerodynamic lift for the return glide.

**Boost Phase:**

Period of powered flight for a glider when the rocket engine is providing thrust.

**Boundary Layer:**

The region next to the surface of a solid body moving through a fluid where there is an appreciable loss of fluid motion relative to the body.

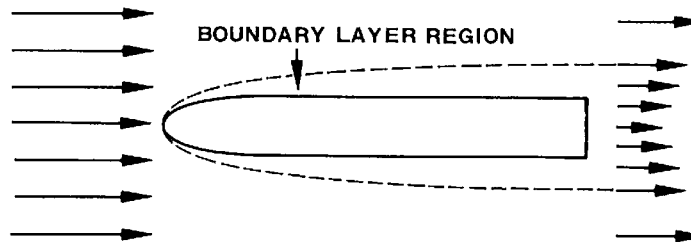

**Camber:**

In aeronautics, the rise of the curve of an airfoil section; usually expressed as the ratio of the departure of the curve from a straight line joining the extremities of the curve to the length of this straight line; camber is positive when the departure is upward and negative when it is downward.

**Canard:**

An airframe configuration with the wings at the rear end and the pitch controlling surface at or near the nose.

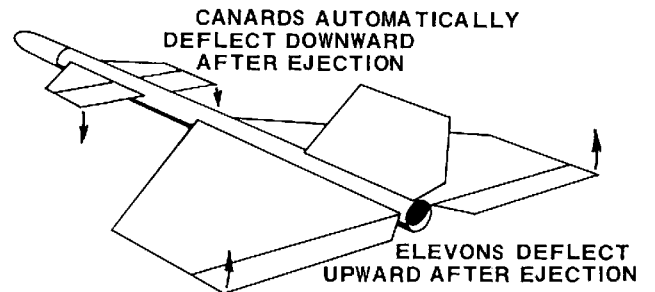

**Coast Phase:**

The period following the boost phase when the model climbs unpowered prior to transition to gliding flight.

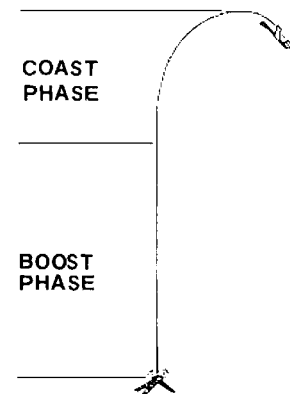

**Constant Taper:**

A wing in which the chord or the thickness progressively decreases from root to tip.

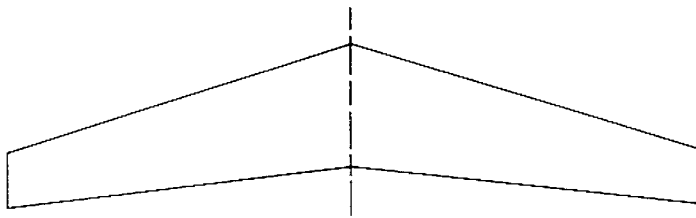

**Convex-concave Airfoil:**

A combination convex-concave curve on the underside of an airfoil.



CONVEX-CONCAVE

**Depressor Bar:**

Small metal bar which holds the elevators in place during boost phase and changes position upon ignition of ejection charge for glide phase.

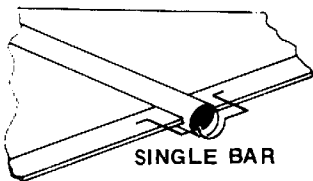

SINGLE BAR

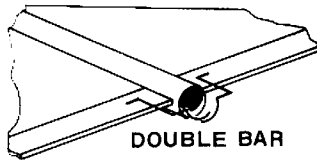

DOUBLE BAR

**Dihedral:**

The upward or downward inclination of a wing or other supporting surface with respect to the horizontal.



DIHEDRAL

**Downwash:**

The vertical downward motion of the airflow induced by, and behind, an airfoil or a wing.

**Elevators:**

The control surface on a boost glider; this surface is designed to change, upon activation, the altitude of the craft from a stable rocket to a gliding object.

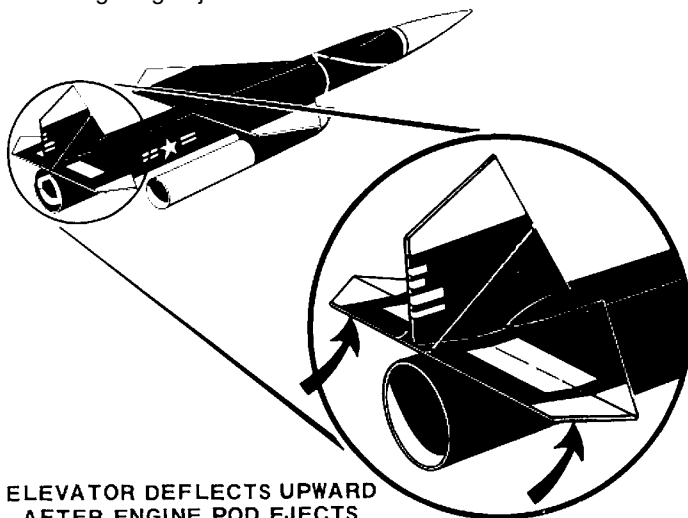

ELEVATOR DEFLECTS UPWARD AFTER ENGINE POD EJECTS

**Elevon:**

An aerodynamic control surface used to control both pitch and roll simultaneously or separately.

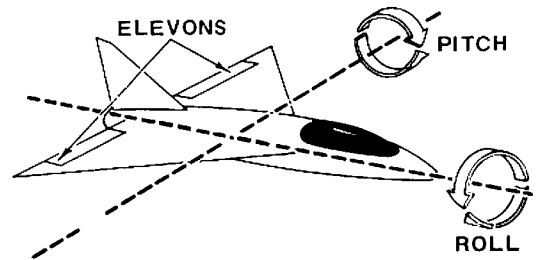

**Empennage Boom:**

Glider frame projecting back from the wings and to which the stabilizer and rudder are attached.

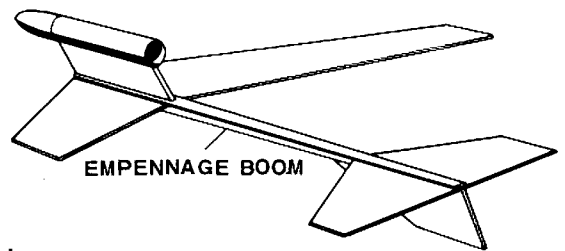

EMPENNAGE BOOM

**Engine Pod:**

Assembly housing model rocket engine that detaches from rest of glider when ejection charge operates.

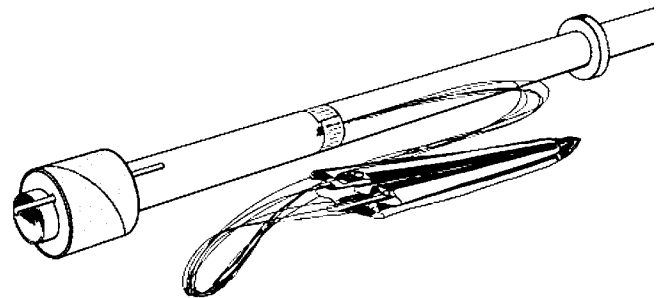

**Flat Bottom Airfoil:**

Airfoil with flat underside.



FLAT BOTTOM

**Glide Phase:**

The non-powered descent of a glider.

**Incidence:**

The angle between the chord line of the airfoil and the longitudinal axis of the glider.



**Irregular Taper:**

A wing in which the chord or thickness does not progressively decrease from root to tip.

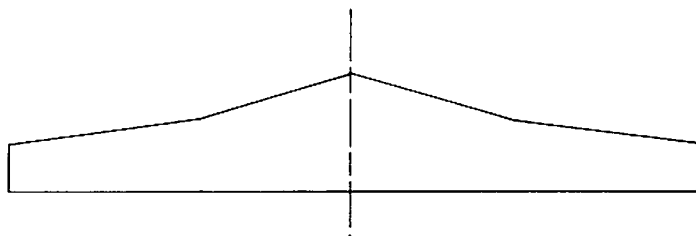

**Laminar Flow:**

Non-turbulent airflow near the surface of a body; airflow parallel to the surface, usually found at the front of a smooth body.

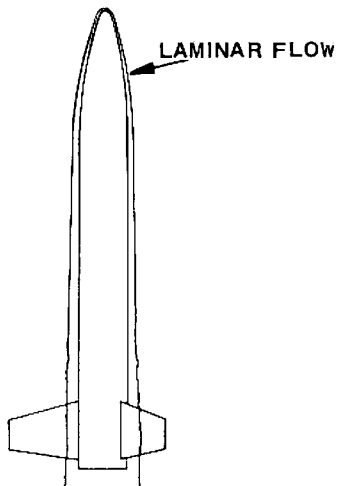

**Lateral Axis:**

The axis from wing tip to wing tip of an aircraft; the aircraft can pitch up or down about this axis.

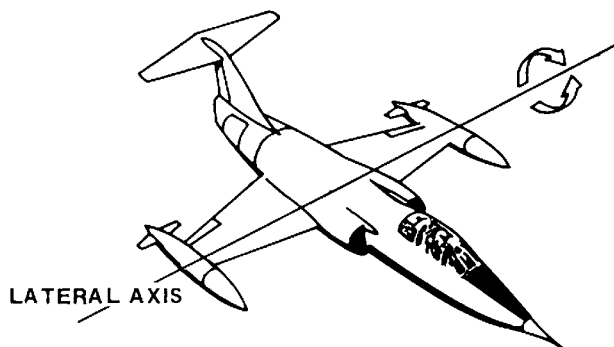

**Lift:**

The component of the total aerodynamic force perpendicular to the relative wind and exerted normally (in an upward direction opposing the force of gravity) to the wings.

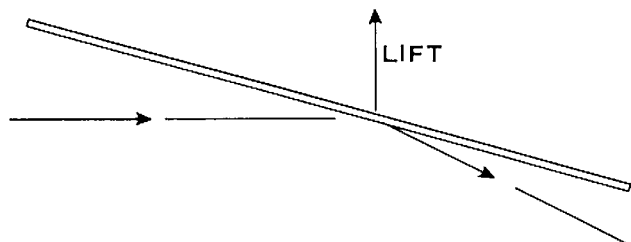

**Longitudinal Axis:**

The axis from the nose to tail of an aircraft; movement about this axis is called roll.

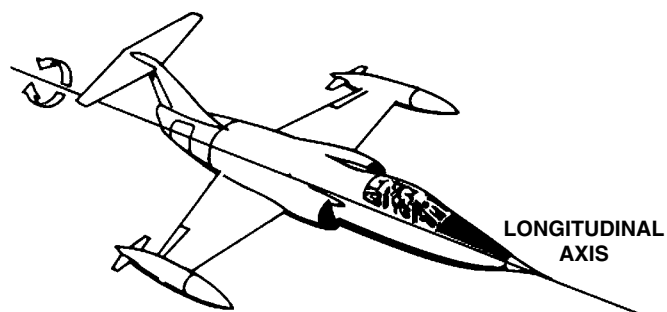

**Oscillation:**

A periodic motion such as the rolling, pitching or yawing of an aircraft or a combination of these.

**Polyhedral:**

A modification of dihedral, wherein the different panels of a wing are tilted upward at varying angles.

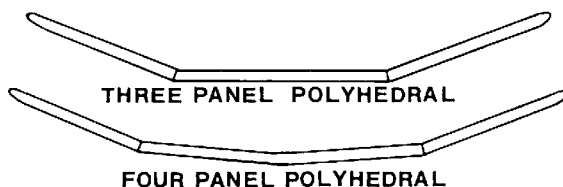

**Pop-pod:**

Engine pod that is jettisoned from glider as the glide phase is initiated.

**Pressure Distribution:**

The variation of air pressure over a surface, such as the pressures around an airfoil.

**Pylon:**

A fin-like mount for the pop-pod.

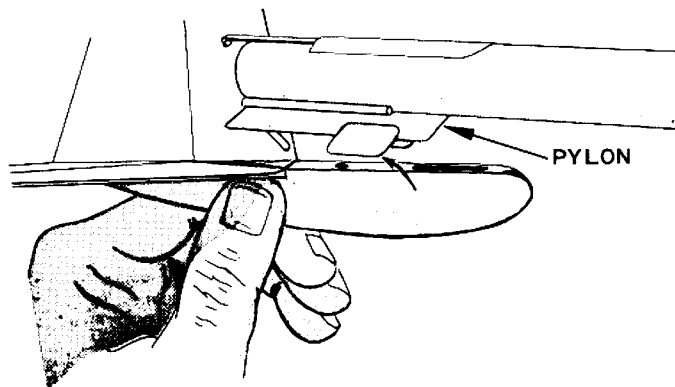

**Relative Wind:**

The direction of the air with reference to a body in it.

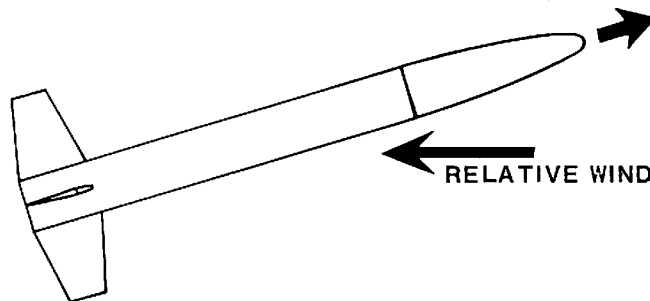

**Rudder:**

A moveable aerodynamic control surface used to cause yaw rotations.

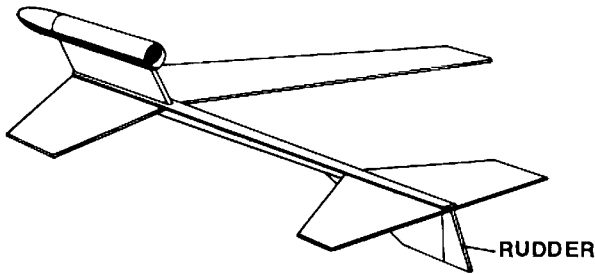

**Stabilizer:**

A fixed stabilizing surface; generally the tail surface on conventional model and the forward surfaces on canard models.

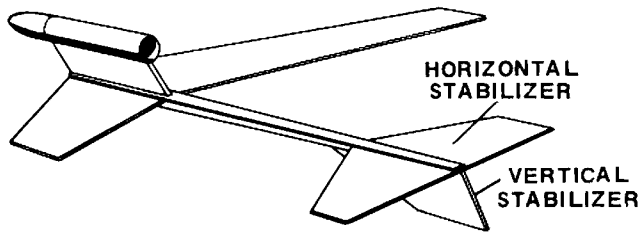

**Taper Ratio:**

The ration of the tip chord to the root chord of a wing; also the ratio of the thickness of the root section to the thickness of the tip section of a wing.

**Tip Vortex:**

Twisting air disturbance at the tip resulting from the wing acting on the air to generate lift.

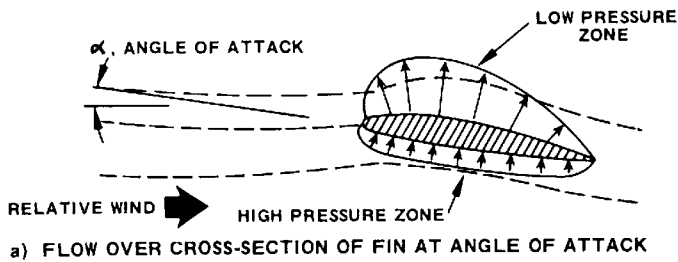

a) FLOW OVER CROSS-SECTION OF FIN AT ANGLE OF ATTACK

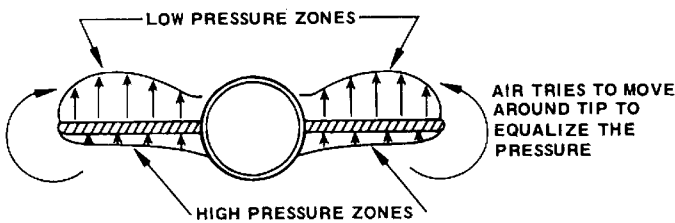

b) FLOW ABOUT FINS, FRONT VIEW OF ROCKET AT ANGLE OF ATTACK

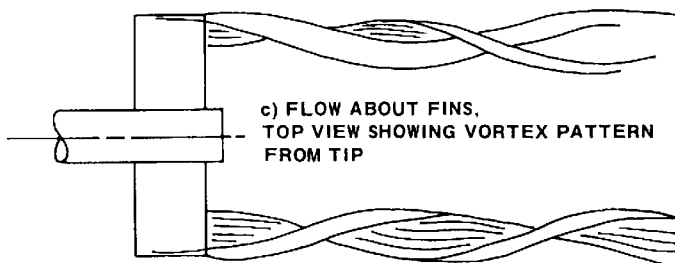

**Uncambered Airfoil:**

An airfoil possessing a concave curve on its underside.



**Vertical Axis:**

The axis extending in a vertical direction from the glider's center of gravity; movement about this axis is called yaw.

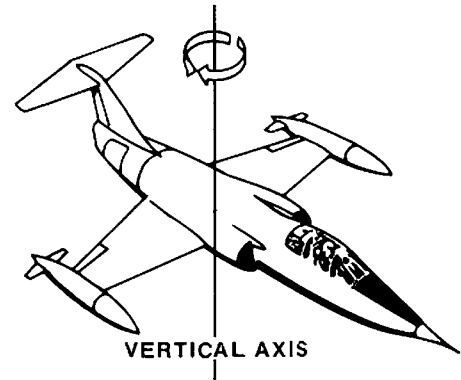

**Vertical Stabilizer:**

The vertical fixed stabilizing surface of a glider.

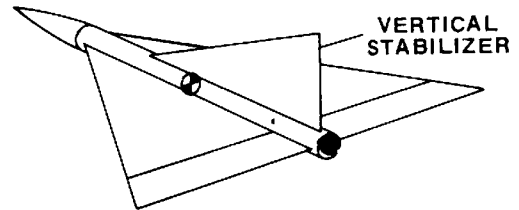

**Warp:**

A twist in the chord line of a surface across its span.

**Wing:**

The main lifting surface of an aircraft.

**Wing Chord:**

The length of a straight line through the centers of curvature of the leading and trailing edges of an airfoil.

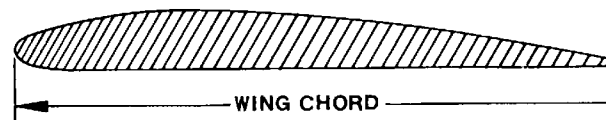

**Wing Loading:**

The gross weight of the glider divided by the gross wing area.

**Wing Span:**

The overall distance between the wing tips of an aircraft.

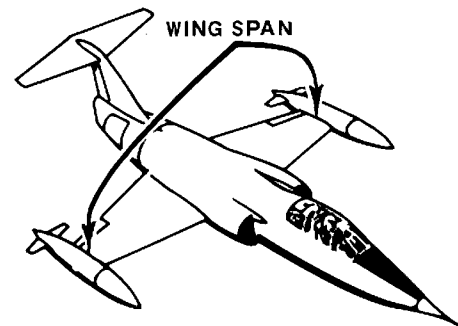

# NOTES

# SECTION REVIEW

## SECTION III

Review what you have learned in Section I, Section II, and Section III before starting this review. Do not refer back to any of the materials you have used while completing this review. Good luck!

Label the parts indicated in this drawing:

1. \_\_\_\_\_
2. \_\_\_\_\_
3. \_\_\_\_\_
4. \_\_\_\_\_
5. \_\_\_\_\_
6. \_\_\_\_\_

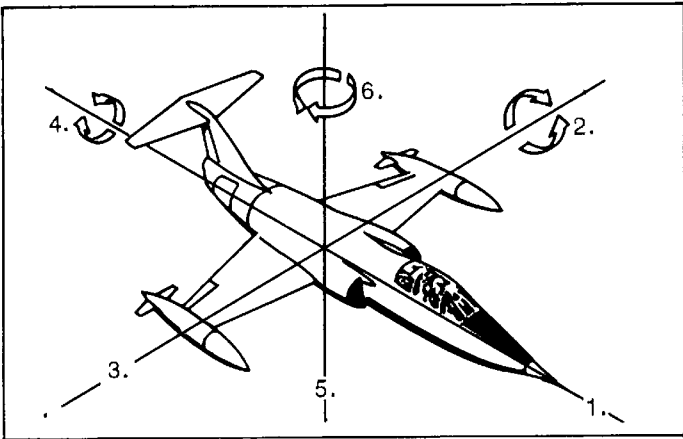

Label the numbered arrows for the force they represent.

7. \_\_\_\_\_
8. \_\_\_\_\_
9. \_\_\_\_\_

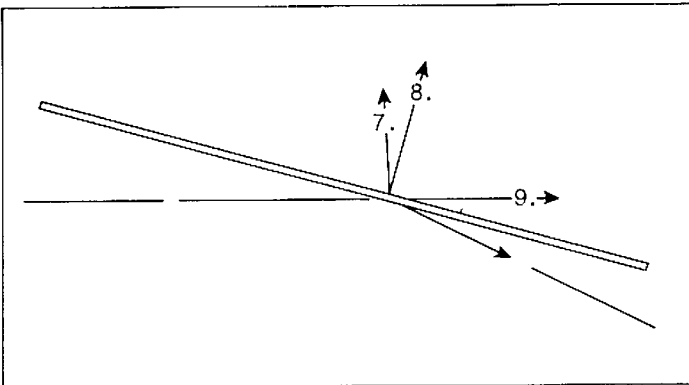

Label the parts indicated on the front engine boost glider.

10. \_\_\_\_\_
11. \_\_\_\_\_
12. \_\_\_\_\_
13. \_\_\_\_\_
14. \_\_\_\_\_
15. \_\_\_\_\_
16. \_\_\_\_\_

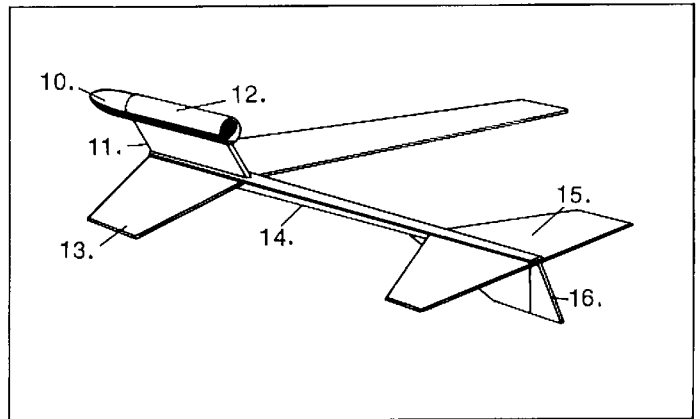

Answer the following questions based on the drawing below.

17. The highest air velocity occurs at \_\_\_\_\_.
18. The highest air pressure against the wing occurs at \_\_\_\_\_.

Diagram

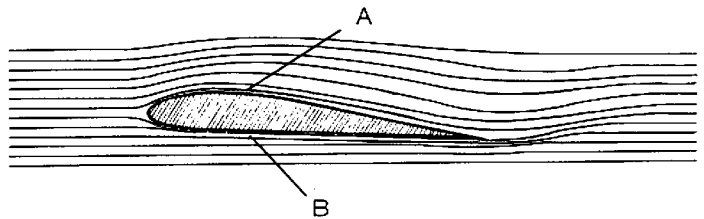

Label the three types of airfoils shown.

19. \_\_\_\_\_  
 20. \_\_\_\_\_  
 21. \_\_\_\_\_

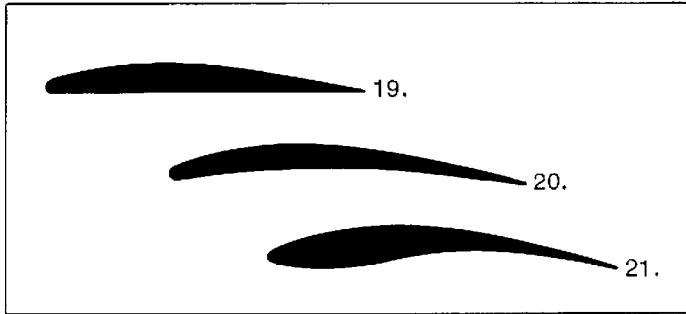

22. The angle between the chord line of the airfoil and the longitudinal axis of the glider is called the angle of \_\_\_\_\_.
23. The gross weight of the glider divided by the gross wing area is called the \_\_\_\_\_.

24. The region next to the surface of a solid body moving through a fluid where there is an appreciable loss of fluid motion relative to the body is called the \_\_\_\_\_.
25. The non-turbulent airflow near the surface of a body is called \_\_\_\_\_ flow.

## ANSWERS

- |   |   |
|---|---|
| <p>25. Laminar<br/>                 24. Boundary layer<br/>                 23. Wing loading<br/>                 22. Incidence<br/>                 21. Convex-concave<br/>                 20. Undercambered<br/>                 19. Flat bottom<br/>                 18. B<br/>                 17. A<br/>                 16. Rudder<br/>                 15. Stabilizer<br/>                 14. Empennage boom</p> | <p>13. Wing<br/>                 12. Engine pod<br/>                 11. Pylon<br/>                 10. Nose cone<br/>                 9. Drag<br/>                 8. Reactive force or net force<br/>                 7. Lift<br/>                 6. Yaw<br/>                 5. Vertical axis<br/>                 4. Roll<br/>                 3. Lateral axis<br/>                 2. Pitch<br/>                 1. Longitudinal axis</p> |
|---|---|

## ANSWERS

# NOTES



# FINAL EXAM

This is not an "open book" exam. Before you start, review what you have learned about model rocketry as you progressed toward becoming an "expert" model rocketeer. Good luck!

1. My model rocket will weight no more than \_\_\_\_ ounces (453 grams) at lift off.
2. The total amount of propellant in my model rocket will not be more than \_\_\_\_ ounces (113 grams).
3. I will always test my model rockets for stability before launching them, except when launching models of proven stability. True or false? \_\_\_\_\_
4. I will use only pre-loaded, factory-made model rocket engines in my solid propellant model rockets. True or false? \_\_\_\_\_
5. My model rockets will be launched by an \_\_\_\_\_ operated launch system.

6. To be aerodynamically stable: \_\_\_\_\_
  - A. The center of gravity should be ahead of the center of pressure.
  - B. The center of gravity and the center of pressure should be in the same place.
  - C. The center of pressure should be ahead of the center of gravity.
7. The total impulse of a C6-5 engine is \_\_\_\_\_ times that of an A8-3 engine.

Name three recovery systems.

8. \_\_\_\_\_
9. \_\_\_\_\_
10. \_\_\_\_\_

Label the parts indicated on this drawing.

11. \_\_\_\_\_
12. \_\_\_\_\_
13. \_\_\_\_\_
14. \_\_\_\_\_
15. \_\_\_\_\_
16. \_\_\_\_\_
17. \_\_\_\_\_
18. \_\_\_\_\_
19. \_\_\_\_\_
20. \_\_\_\_\_
21. \_\_\_\_\_

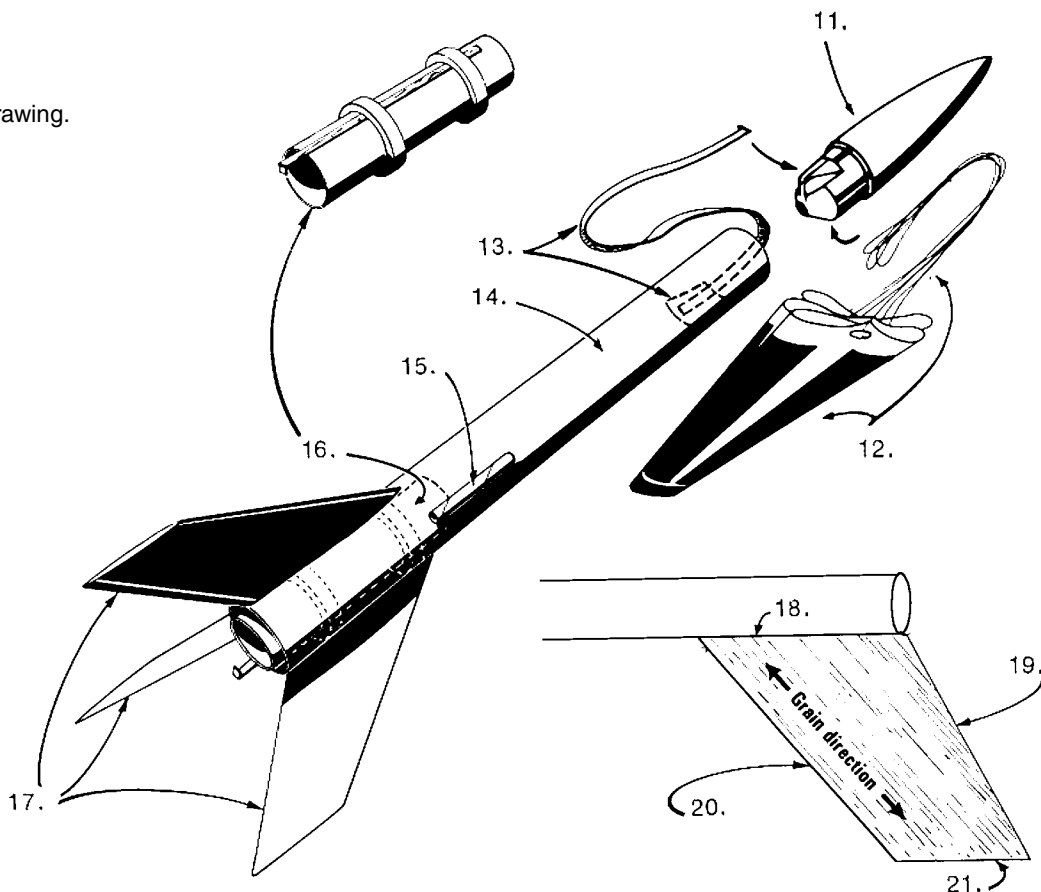

Label the parts shown in this drawing of a model rocket engine.

22. \_\_\_\_\_
23. \_\_\_\_\_
24. \_\_\_\_\_
25. \_\_\_\_\_
26. \_\_\_\_\_
27. \_\_\_\_\_

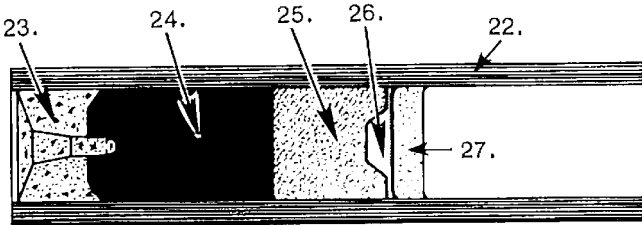

28. A D12-5 engine has a total impulse of \_\_\_\_\_ newton-seconds.
29. The D12-5 engine has a delay element, which activates the ejection charge \_\_\_\_\_ seconds after the propellant is consumed.
30. A C6-0 engine would be used to: \_\_\_\_\_
  - A. Launch a large, heavy, single-stage model rocket
  - B. As the engine in a booster stage of a multi-stage model rocket
  - C. As the sustainer engine in a multi-stage model rocket
31. Calculate the height of the model rocket at point B. \_\_\_\_\_ feet.

Given: baseline  $b = 500$  ft.  
 $\angle A = 42^\circ$

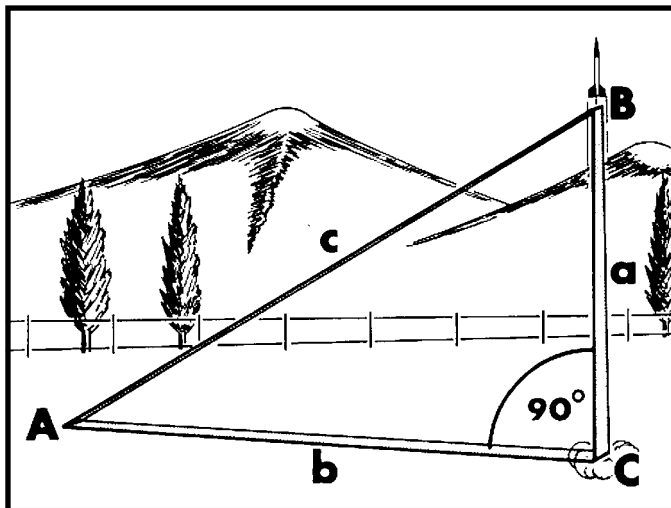

32. My model rockets will always be pointed within \_\_\_\_\_ degrees of vertical.
33. A cluster of 3 A8-3 engines produces \_\_\_\_\_ times the total impulse of one A8-3 engine.
34. The total impulse of a model rocket engine is indicated by the: \_\_\_\_\_
  - A. First letter (or fraction and letter) of the engine classification
  - B. The first number (not a fraction) of the engine classification
  - C. The second number (after the dash) of the engine classification
35. Which will accelerate a given model rocket faster, a B8-5 engine or a B4-6 engine? \_\_\_\_\_
36. Solid propellant is composed of a mixture of \_\_\_\_\_
37. and \_\_\_\_\_.
38. Burnout occurs when the rocket engine \_\_\_\_\_.
39. The edge at which the fin or wing is attached to the tube is called the \_\_\_\_\_.
40. The length of time during which a model rocket is airborne is called the \_\_\_\_\_.
41. Rotational movement around the lateral axis of a craft is called \_\_\_\_\_.
42. The science of sending data from a rocket back to earth is called \_\_\_\_\_.
43. Non-turbulent airflow near the surface of a body is called \_\_\_\_\_ flow.

TABLE OF TANGENTS					
ANGLE	TAN.	ANGLE	TAN.	ANGLE	TAN.
1°	.02	28°	.53	54°	1.38
2°	.03	29°	.55	55°	1.45
3°	.05	30°	.58	56°	1.48
4°	.07	31°	.60	57°	1.54
5°	.09	32°	.62	58°	1.60
6°	.11	33°	.65	59°	1.66
7°	.12	34°	.67	60°	1.73
8°	.14	35°	.70	61°	1.80
9°	.16	36°	.73	62°	1.88
10°	.18	37°	.75	63°	1.96
11°	.19	38°	.78	64°	2.05
12°	.21	39°	.81	65°	2.14
13°	.23	40°	.84	66°	2.25
14°	.25	41°	.87	67°	2.36
15°	.27	42°	.90	68°	2.48
16°	.29	43°	.93	69°	2.61
17°	.31	44°	.97	70°	2.75
18°	.32	45°	1.00	71°	2.90
19°	.34	46°	1.01	72°	3.08
20°	.36	47°	1.07	73°	3.27
21°	.38	48°	1.11	74°	3.49
22°	.40	49°	1.15	75°	3.73
23°	.42	50°	1.19	76°	4.01
24°	.45	51°	1.23	77°	4.33
25°	.47	52°	1.28	78°	4.70
26°	.49	53°	1.33	79°	5.14
27°	.51			80°	5.67

44. The axis from wing tip to wing tip of an aircraft is called the \_\_\_\_\_ axis.

45. The velocity of air with reference to a body in it is called the \_\_\_\_\_.

Label the parts in this drawing:

46. \_\_\_\_\_

47. \_\_\_\_\_

48. \_\_\_\_\_

49. \_\_\_\_\_

50. \_\_\_\_\_

51. \_\_\_\_\_

52. The overall distance between the wing tips of an aircraft is called the \_\_\_\_\_.

Label the arrows to indicate the force which each represents.

53. \_\_\_\_\_

54. \_\_\_\_\_

55. \_\_\_\_\_

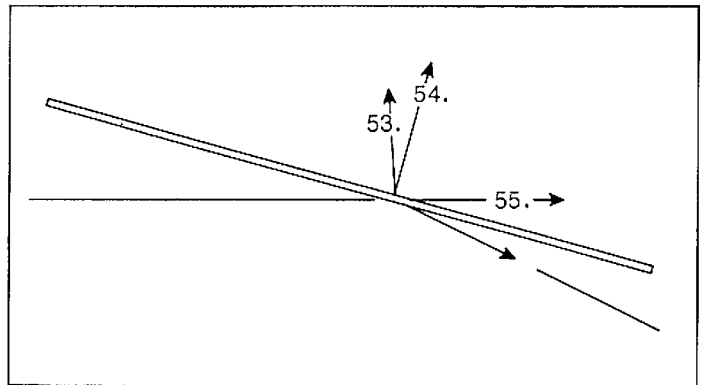
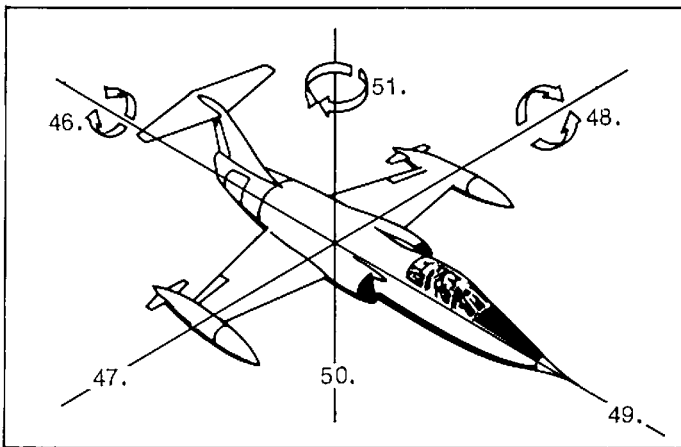

To find out your exam score, mail the exam to  
Estes Educator™, Estes Industries,  
1295 H Street, Penrose, Colorado 81240.  
We will grade your exam and return it to you with your  
“Expert Model Rocketeer Award Certificate”.



**MODEL ROCKETRY STUDY GUIDE - "PROJECT/FLIGHT RECORD"**

SECTION I	PROJECT DESCRIPTION	DATES: COM-BEGUN PLETED	REF. MAT. READ OR TESTS TAKEN	ROCKET: NAME/TYPE	STABLE FLIGHT	PERFORMANCE: DURATION/ALT.	SUCCESSFUL RECOVERY	ATTEST: SELF OR WITNESS
T-10								
T-9								
T-8								
T-7								
T-6								
T-5								
T-4								
T-3								
T-2								
T-1								
*SECTION REVIEW								
<b>SECTION II</b>								
T-10								
T-9								
T-8								
T-7								
T-6								
T-5								
T-4								
T-3								
T-2								
T-1								
*SECTION REVIEW								
<b>SECTION III</b>								
T-3								
T-2								
T-1								
*SECTION REVIEW								
<b>**EXPERT ROCKETEER FINAL EXAM</b>								

ROCKETEER'S NAME \_\_\_\_\_

ADDRESS \_\_\_\_\_

CITY \_\_\_\_\_ STATE \_\_\_\_\_ ZIP CODE \_\_\_\_\_ DATE \_\_\_\_\_ WITNESS \_\_\_\_\_ ROCKETEER \_\_\_\_\_

I hereby certify that I have successfully completed, in strict accordance with the Model Rocketry Safety Code, the projects offered in the Model Rocketry Study Guide.

